



# User Manual

---

Version 4.2

## DC System Monitor: FR-DCMG-MMPY



丰郅（上海）新能源科技有限公司  
Fonrich (Shanghai) New Energy Technology Co., Ltd.

Add: 1st Floor, Building 5, No.999 Jiangyue Road, Minhang District, Shanghai  
Web: [www.fonrich.com](http://www.fonrich.com)  
Tel: +86 21 61679671  
Email: [sales@fonrich.com](mailto:sales@fonrich.com)

# Table of Contents

Product description	3
The main function	3
Documentation statement	3
Terminal definition	4
Controller connection diagram	5
Ground connection and communication shield	6
Operation interface display	7
Key operation	7
Initial interface display	7
Histogram interface	7
Channel current and power generation display interface	9
Parameter setting interface	10
Current calibration setting interface	10
Software version number display interface	10
Alarm status display interface	11
Channel arc fault alarm interface	11
Fault alarm clear interface	11
Items that can generate alarms can be set	12
Alarm conditions	12
Alarm message	13
MODBUS Protocol definition	14
Communication format configuration	14
Data frame format description (refer to Modbus RTU standard)	14
Function code description	14
Register description	15
Register description in bit units (function code 02)	15
Register description in word unit (function code 03 04 06)	28
Appendix	34
FAQ	34
Document revision record	35
Contact us	37

# Product description

---

FR-DCMG DC monitor products are mainly used in DC power transmission and distribution, such as photovoltaic combiner boxes, DC cabinets, telecommunications equipment rooms and communication base stations. It communicates with the host computer through RS485 or industrial wireless. Its main function is to monitor the current of each branch in the DC system, the bus voltage, the temperature of the cabinet, the status of the lightning arrester and the status of the DC breaker. It can realize automatic alarm for abnormal conditions and real-time detection of the presence of harmful arcs in the DC circuit.

## The main function

- Monitoring function: Real-time monitoring of the generation current, voltage, temperature of the combiner box, lightning arrester status, DC circuit breaker status, and DC arc fault status of each photovoltaic string in the combiner box, and communicate with the host computer through RS485.
- Display content: For the detected voltage, current, temperature, switching state, power generation and other data, the FR-DCMG-MMPY can display a histogram interface through the LCD to read the current and other data more intuitively.
- Alarm function: It can be configured to open or close the alarm according to the actual needs of the scene. When the alarm occurs, the interface will pop up an alarm message.
- Current calibration: identify zero drift and improve the accuracy of current identification. (Default off)
- Compatibility: Program compatible model FR-DCMG-MMPD products

## Documentation statement

This manual is applicable to the monitoring host whose model is FR-DCMG-MMPY.

The software version is A0F2.

See page 11 for software version viewing method

## Terminal definition

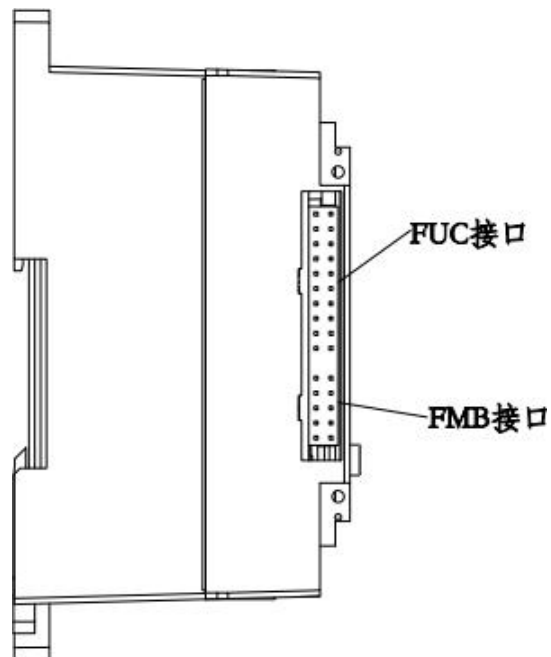
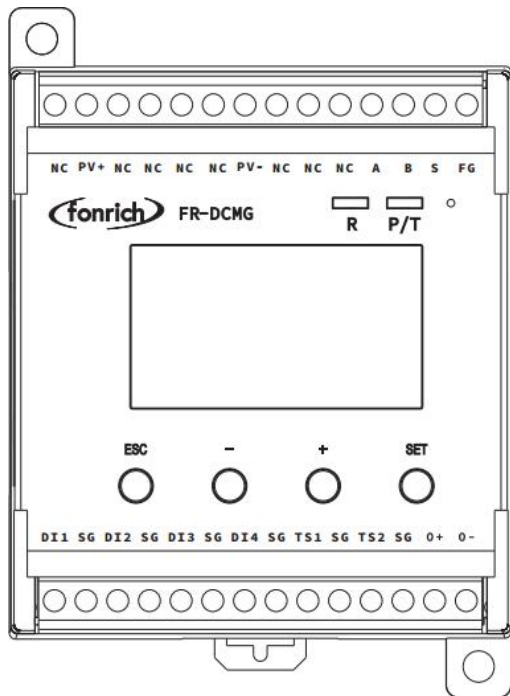

Symbol	Meaning
PV+ . PV-	PV DC bus power supply terminal
NC	Not connecion
S	Not connecion
A.B	RS485 Communication terminal
FG	Fixed Ground terminal
TS1.TS2	Externally connected temperature sensor terminals
SG	Temperature sensor and digital input ground terminal
DI1.DI2.DI3.DI4	4 digital input terminals
FUC	Can connect modules with FUC interface
FMB	Modules with an FMB interface can be connected, such as the FR-DCMG-AS4A DC Arc Detector.

# Controller connection diagram

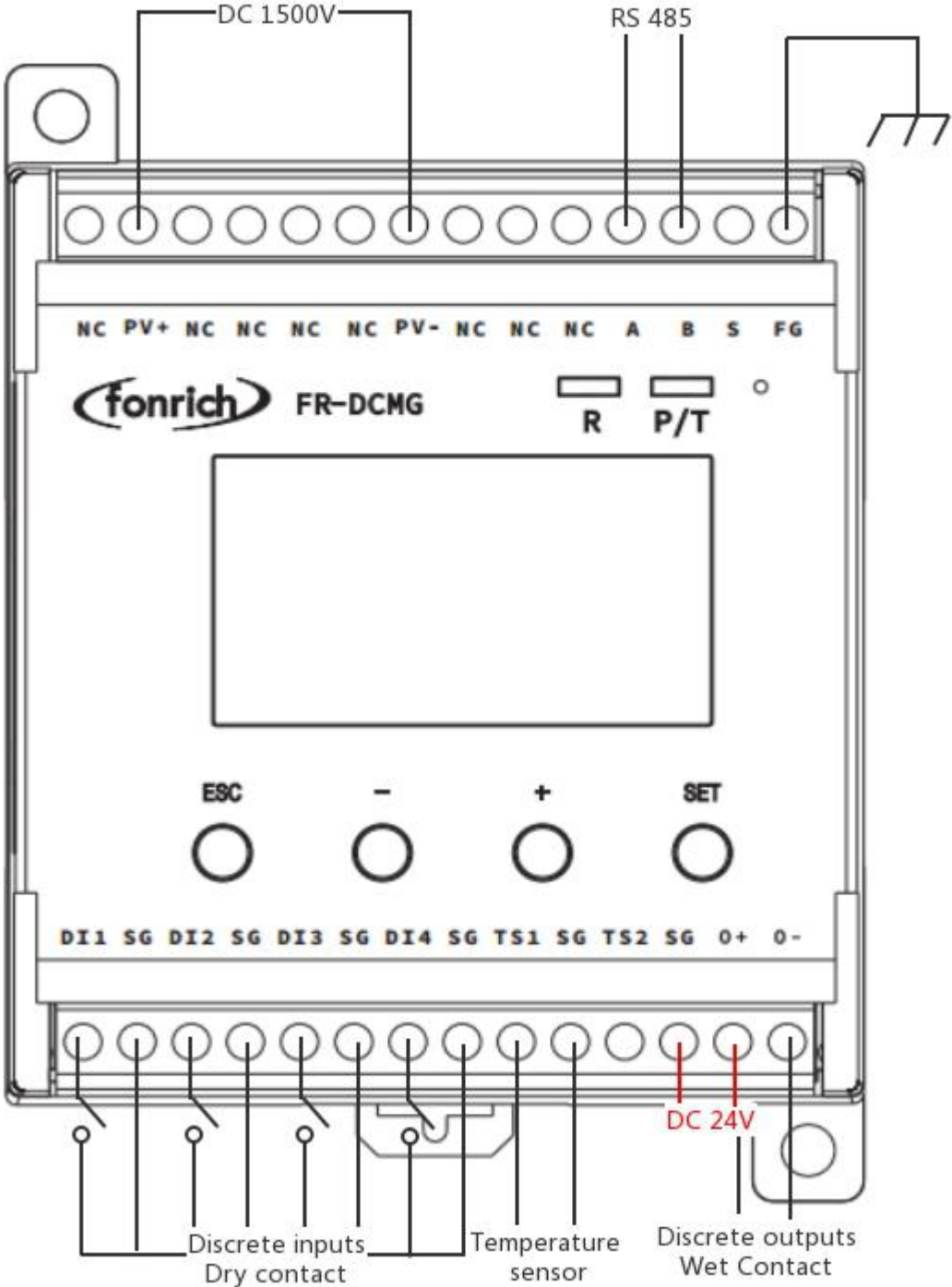

# Ground connection and communication shield

The FG terminal of the FR-DCMG must be grounded, otherwise communication will interfere and the reliability of the device will decrease. The grounding wire should be grounded nearby. The grounding wire should be no more than 15cm from the "FG" terminal to the bottom of the combiner box. It is recommended to be within 10cm. The shorter the better, the thicker the better. The bottom of the combiner box should be connected to the ground. The main control unit module is fixed on a standard guide rail with a width of 3.5 cm.

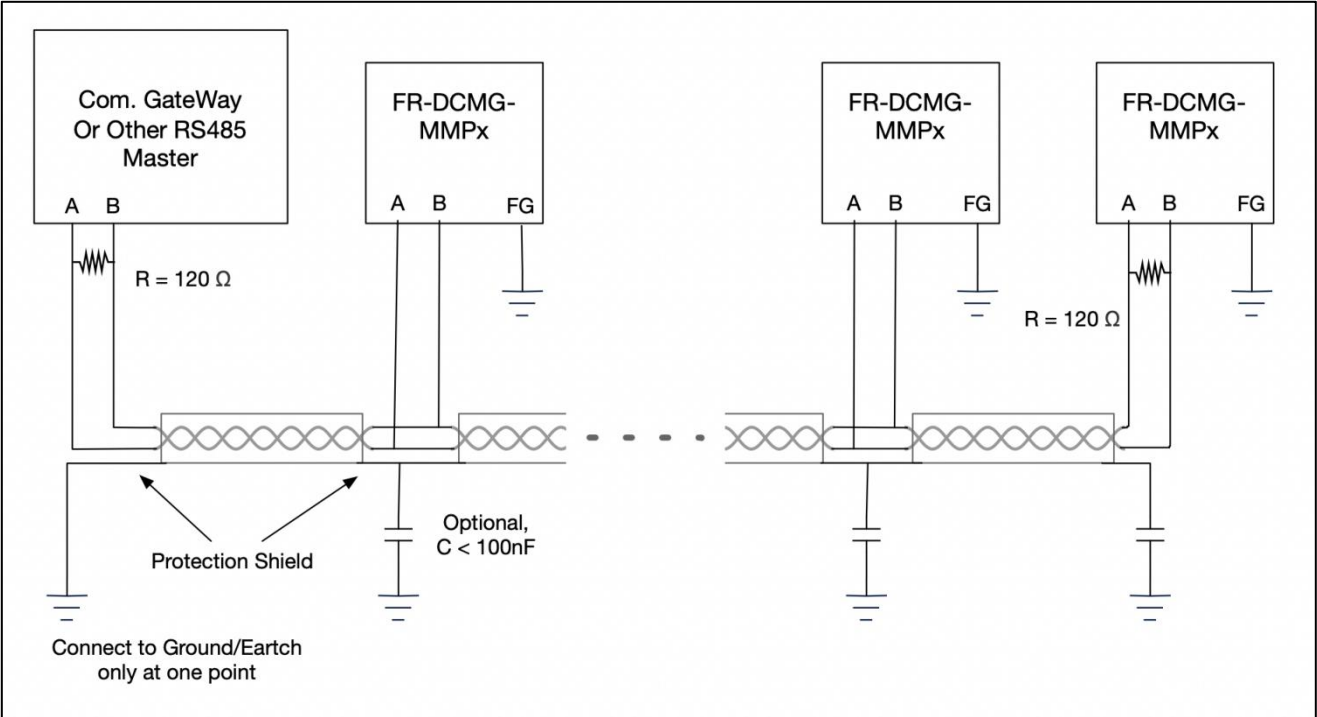

The wiring specifications of the communication shielded wire are shown in the figure above: The wiring of on-site communication lines requires that the communication shield can only be grounded at a single point, otherwise there will be a risk of lightning surge damage to all equipment on the entire communication line during a lightning strike;

If you encounter a situation where communication line interference is too large to communicate, you can refer to the figure above, and insert a high voltage capacitor  $C < 100nF$  between the shielded wire of each combiner box and the ground wire, and use this capacitor to filter the shielding layer interference.

# Operation interface display

## Key operation

FR-DCMG-MMPY has four keys "ESC" , "-" , "+" , and "SET" .

"ESC" key is used to return to the default interface and cancel parameter setting;

"SET" key is used to enter the parameter setting mode, select the parameter to be set and complete the setting of the parameter;

The "+" and "-" keys are used to scroll the screen and adjust parameters;

Press the "+" and "-" keys at the same time to display the software version interface;

Press the "ESC" and "-" keys simultaneously to display the current calibration interface;

If there is no key operation for 10 seconds, the interface will automatically jump to the default interface of the current mode, and the brightness will decrease after 5 seconds.

## Initial interface display

The factory default is Modbus mode. When the host computer is connected to the device via RS485 and communicates, the LED lights "R" and "P / T" will flash alternately to indicate normal communication. When the device is not connected to communication, it restarts by default every 5 minutes, or you can turn off the default restart function, which can be turned off through the 0xF003 register.

## Histogram interface

The histogram interface is the default display interface of Modbus mode, as shown below:

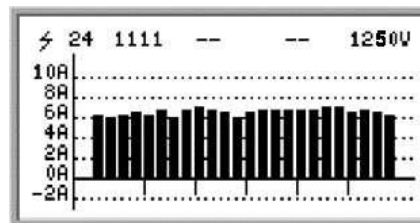

The histogram in the figure shows the current value detected by each channel. The initial interface display range is: -2A ~ 10A. You can also set register 0x0B16, which displays -2A ~ 20A and -2A ~ 30A. Because a six-channel Hall sensor is connected, every

six channels are distinguished during display, and the current channels are from 1 to 24 in order from left to right. The order of the current channels can also be set in reverse order. The lightning icon in the upper left corner indicates that the FR-DCMG-MMPY horn-connected Hall sensor with arc monitoring function; "24" indicates the current online arc and current channel number; "1111" indicates the real-time status of the digital input DI1 ~ DI4; "1250V" Represents the real-time voltage value of the bus. If there is no key operation within 5 seconds, the screen brightness will decrease.



## Channel current and power generation display interface

In the histogram mode, press the "+" or "-" key to enter the channel current and power generation display interface. The current value and cumulative power generation of each channel are displayed on the screen. When the "+" key is pressed first, the digital value of the current is displayed first, and when the "-" is pressed first, the digital value of the current is displayed first

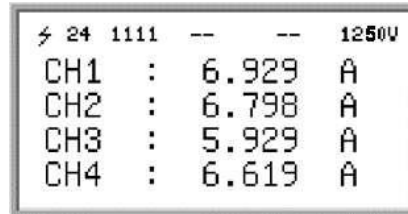

The value of cumulative power generation. When viewing the values of current and cumulative power generation, you can scroll through the screen by continuing to press the "+" or "-" key. After the current display is completed, continue to press the "+" key to start displaying the cumulative power generation. The figure above shows the current display interface. "CH1:" in the figure indicates that the current value monitored by channel 1 in real time is "6.929A" , and so on.

The figure below shows the cumulative power generation display interface. "CH1:" in the figure indicates that the cumulative power generation of channel 1 is "6.929kwh", and so on.

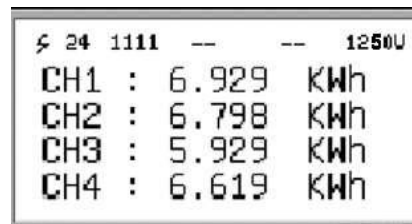

## Parameter setting interface

In the histogram interface, press the "SET" key to enter the Modbus parameter setting interface. The Modbus parameter setting is as follows:

Device Setting	
ADDR :	247
PAR :	None
BPS :	9600

- ADDR: The communication address of the Modbus slave node, the range is 1 ~ 247 (default is 247).
- PAR: The data verification method of Modbus communication. The optional parity (None), odd parity (Odd), even parity (Even), and no parity by default.
- BPS: Baud rate for Modbus communication. The selectable baud rates are 2400, 4800, 9600 (default), 19200, 38400.

## Current calibration setting interface

Press the "ESC" and "-" keys at the same time to enter the current calibration setting interface, as shown below:

CALIBRATE
AUTO OFF
MUNUAL OFF

To use this feature, please contact the company's technical support staff.

## Software version number display interface

In the histogram interface, press the "+" and "-" keys at the same time to enter the software version number display interface, as shown below:

CBM Information	
HV :	FFFF
SV :	A0F2
ST :	0

- HV: Keep
- SV: Software version number
- ST: Keep

## Alarm status display interface

Alarm messages can be cleared remotely and manually. Manual clearing requires long-pressing the host's "ESC" key for 2 seconds, remote clearing requires writing "1" to register 0x0079 to clear. If an arc alarm occurs, it must be cleared manually or remotely. Restarting the host will still display the alarm message.

## Channel arc fault alarm interface

After the DC arc sensor detects the occurrence of a fault arc, the alarm information interface of the host is as shown below.

ALARM TRIP
02 — 4
CH Arc Alarm

In the figure above: "02" means channel arc fault alarm, and "4" means that the fault arc alarm channel is 4.

## Fault alarm clear interface

The host sends an alarm when it detects a fault, and the user can choose to handle it locally or remotely. By long-pressing the "ESC" key for about 2 seconds locally, the

system jumps out of the interface as shown below, indicating that the alarm status has been cleared; remote processing needs to write "1" to 0x0079 to clear, and the interface shown below will be displayed after clearing successfully.



### **Items that can generate alarms can be set**

- Voltage is too high
- Voltage is too low
- Temperature is too high
- Channel reverse current
- Total reverse current is too high
- Total current is too high
- Total current is too low
- Channel without current
- Low channel current
- High channel current
- Channel current value undercurrent
- Channel current value overcurrent
- Lightning Arrester Status (DI1)
- circuit breaker status (DI2)
- Switch DI3 status
- Switch DI4 status

### **Alarm conditions**

1. Current reverse, no current, under current, over current, low current, high current, etc.
  - a. Only when the average value of the channel current is greater than the set alarm threshold of the current channel, the alarm function of the above current-related items is activated; otherwise, the alarm status is forcibly cleared to 0.
  - b. As for whether the alarm needs to be separately met the respective alarm conditions (above or below the respective alarm threshold).[Alarm message](#)
  - c. Check if the corresponding alarm register is open, closed by default

## Alarm message

- Undercurrent alarm. After the channel average current value is subtracted from the overcurrent / undercurrent alarm threshold, the current value is still less than or equal to the current channel start alarm start threshold. The overcurrent / undercurrent alarm threshold will change as the average current changes.[Alarm message](#)
- Over current alarm. After the channel average current value plus the over current / under current alarm threshold, the current value is still greater than or equal to the current channel start alarm start threshold. The over current / under current alarm threshold will change as the average current changes.[Alarm message](#)
- Low current alarm, when the current is less than or equal to the channel current low alarm threshold, an alarm occurs.[Alarm message](#)
- High current alarm. When the current is greater than or equal to the channel current high alarm threshold, an alarm occurs.[Alarm message](#)
- No current alarm, when the absolute value of the current is less than 250mA, an alarm occurs.[Alarm message](#)

# MODBUS Protocol definition

## Communication format configuration

- Modbus communication mode: RTU mode
- Address of the slave device: range form 1 to 247 (default 247)
- Baud rate (bps): 2400, 4800, 9600 (default), 19200, 38400
- Byte check mode: odd check, even check, no check (default)

## Data frame format description (refer to Modbus RTU standard)

The byte in the communication frame composed by 1 start bit, 8 bits data bit, 1 parity bit, 1 stop bit like the below table (Refer to standard modbus RTU protocol):

Table 1: Data frame format table

Address Code	Function Code	Data Area	Check Zone
1byte	1byte	N*1byte	2bytes

The address code is used to identify the slave that receives the data frame and the response frame sent by that slave. The function code indicates how the master requires the slave to respond and the slave responds to that function code. Data area The content can be the address value, the number of registers, the data from the slave response and the data sent by the master to the slave, etc., which can hold up to 252 bytes of data. The check area uses CRC cyclic redundancy to check whether a frame of data is wrong. The high byte of the data frame comes first, and the low byte comes after.

## Function code description

### Register reads and writes in bits

- Function code 01 used to read the contents of the bit register
- Function code 02 used to reads the contents of the bit register
- Function code 05 used to write single bit-type registers

The contents represented by the register in bits are: switch value, alarm information, etc.

## Register read and write in word units

- Function codes 03、 04 are used to read multiple word-type registers
- Function code 06 is used to write single word-type registers
- Function code 16 is used to multiple word-type registers

The content of the word-type registers can be voltage, current, generated energy, etc

## Register description

### Register description in bit units (function code 02)

Bit address		Functional description	remark
Hex	Decimal		
0x021E	542	-	-
0x0230	560	-	-
0x0231	561	Channel arc alarm status	This bit is set when the channel arc strength is above the alarm threshold. Clear the alarm and set it to 0.
0x0232	562	Bus voltage too low alarm status	This bit is set when the bus voltage is below the alarm threshold. Cleared below the alarm release threshold
0x0233	563	Bus voltage to high alarm status	This bit is set when the bus voltage exceeds the alarm threshold. Cleared below the alarm release threshold
0x0234	564	Temperature sensor 1 high temperature alarm status	This bit is set when the temperature sensor 1 temperature exceeds the alarm threshold. Cleared below the alarm release threshold
0x0235	565	Temperature sensor 2 high temperature alarm status	This bit is set when the temperature sensor 2 temperature exceeds the alarm threshold. Cleared below the alarm release threshold
0x0236	566	Channel reverse current	When the reverse current is generated in the channel, the

		alarm status	position is 1, and the alarm is cleared.
0x0237	567	Total reverse current alarm status	This bit is set when the total reverse current exceeds the alarm threshold. Cleared below the alarm release threshold
0x0238	568	Total current too low alarm state	This bit is set when the total current exceeds the alarm threshold. Cleared below the alarm release threshold
0x0239	569	Total current too high alarm state	This bit is set when the total current exceeds the alarm threshold. Cleared below the alarm release threshold
0x023A	570	Channel current value zero	The channel has no current alarm and this bit is set to 1.
0x023B	571	Channel current value undercurrent	Channel undercurrent alarm, this bit is set to 1
0x023C	572	Channel current value overcurrent	Channel overcurrent alarm, this bit is set to 1.
0x023D	573	Channel current value is too low	Channel current low alarm, this bit is set to 1
0x023E	574	Channel current value is too high	Channel current high alarm, this bit is set to 1
0x0240	576	Switch 1 alarm status	The state of the device's input switch DI1, 0: open, 1: closed
0x0241	577	Switch 2 alarm status	The state of the device's input switch DI2, 0: open, 1: closed
0x0242	578	Switch 3 alarm status	The state of the device's input switch DI3, 0: open, 1: closed
0x0243	579	Switch 4 alarm status	The state of the device's input switch DI4, 0: open, 1: closed
.....	.....	.....	.....
0x0260	608	Channel 1 arc alarm status	When the arc intensity of the channel is greater than the alarm threshold, this bit is set to 1; after clearing the alarm, it is set to 0
0x0261	609	Channel 2 arc alarm status	When the arc intensity of the channel is greater than the alarm threshold, this bit is set to 1; after clearing the alarm, it is set to 0
0x0262	610	Channel 3 arc alarm status	When the arc intensity of the channel is greater than the alarm threshold, this bit is set to 1; after clearing the alarm, it is set to 0
0x0263	611	Channel 4 arc alarm status	When the arc intensity of the channel is greater than the alarm threshold, this bit is set to 1; after clearing the alarm, it is set to 0



			0
0x0264	612	Channel 5 arc alarm status	When the arc intensity of the channel is greater than the alarm threshold, this bit is set to 1; after clearing the alarm, it is set to 0
0x0265	613	Channel 6 arc alarm status	When the arc intensity of the channel is greater than the alarm threshold, this bit is set to 1; after clearing the alarm, it is set to 0
0x0266	614	Channel 7 arc alarm status	When the arc intensity of the channel is greater than the alarm threshold, this bit is set to 1; after clearing the alarm, it is set to 0
0x0267	615	Channel 8 arc alarm status	When the arc intensity of the channel is greater than the alarm threshold, this bit is set to 1; after clearing the alarm, it is set to 0
0x0268	616	Channel 9 arc alarm status	When the arc intensity of the channel is greater than the alarm threshold, this bit is set to 1; after clearing the alarm, it is set to 0
0x0269	617	Channel 10 arc alarm status	When the arc intensity of the channel is greater than the alarm threshold, this bit is set to 1; after clearing the alarm, it is set to 0
0x026A	618	Channel 11 arc alarm status	When the arc intensity of the channel is greater than the alarm threshold, this bit is set to 1; after clearing the alarm, it is set to 0
0x026B	619	Channel 12 arc alarm status	When the arc intensity of the channel is greater than the alarm threshold, this bit is set to 1; after clearing the alarm, it is set to 0
0x026C	620	Channel 13 arc alarm status	When the arc intensity of the channel is greater than the alarm threshold, this bit is set to 1; after clearing the alarm, it is set to 0
0x026D	621	Channel 14 arc alarm status	When the arc intensity of the channel is greater than the alarm threshold, this bit is set to 1; after clearing the alarm, it is set to 0
0x026E	622	Channel 15 arc alarm status	When the arc intensity of the channel is greater than the alarm threshold, this bit is set to 1; after clearing the alarm, it is set to 0
0x026F	623	Channel 16 arc alarm status	When the arc intensity of the channel is greater than the alarm threshold, this bit is set to 1; after clearing the alarm, it is set to 0

0x0270	624	Channel 17 arc alarm status	When the arc intensity of the channel is greater than the alarm threshold, this bit is set to 1; after clearing the alarm, it is set to 0
0x0271	625	Channel 18 arc alarm status	When the arc intensity of the channel is greater than the alarm threshold, this bit is set to 1; after clearing the alarm, it is set to 0
0x0272	626	Channel 19 arc alarm status	When the arc intensity of the channel is greater than the alarm threshold, this bit is set to 1; after clearing the alarm, it is set to 0
0x0273	627	Channel 20 arc alarm status	When the arc intensity of the channel is greater than the alarm threshold, this bit is set to 1; after clearing the alarm, it is set to 0
0x0274	628	Channel 21 arc alarm status	When the arc intensity of the channel is greater than the alarm threshold, this bit is set to 1; after clearing the alarm, it is set to 0
0x0275	629	Channel 22 arc alarm status	When the arc intensity of the channel is greater than the alarm threshold, this bit is set to 1; after clearing the alarm, it is set to 0
0x0276	630	Channel 23 arc alarm status	When the arc intensity of the channel is greater than the alarm threshold, this bit is set to 1; after clearing the alarm, it is set to 0
0x0277	631	Channel 24 arc alarm status	When the arc intensity of the channel is greater than the alarm threshold, this bit is set to 1; after clearing the alarm, it is set to 0
.....	.....	.....	.....
0x027F	639	Channel 32 arc alarm status	When the arc intensity of the channel is greater than the alarm threshold, this bit is set to 1; after clearing the alarm, it is set to 0
0x0280	640	Channel 1 current reverse alarm status	This bit is set when the channel current is reversed and greater than the alarm threshold, otherwise cleared.
0x0281	641	Channel 2 current reverse alarm status	This bit is set when the channel current is reversed and greater than the alarm threshold, otherwise cleared.
0x0282	642	Channel 3 current reverse alarm status	This bit is set when the channel current is reversed and greater than the alarm threshold, otherwise cleared.
0x0283	643	Channel 4 current reverse alarm status	This bit is set when the channel current is reversed and greater than the alarm threshold, otherwise cleared.

0x0284	644	Channel 5 current reverse alarm status	This bit is set when the channel current is reversed and greater than the alarm threshold, otherwise cleared.
0x0285	645	Channel 6 current reverse alarm status	This bit is set when the channel current is reversed and greater than the alarm threshold, otherwise cleared.
0x0286	646	Channel 7 current reverse alarm status	This bit is set when the channel current is reversed and greater than the alarm threshold, otherwise cleared.
0x0287	647	Channel 8 current reverse alarm status	This bit is set when the channel current is reversed and greater than the alarm threshold, otherwise cleared.
0x0288	648	Channel 9 current reverse alarm status	This bit is set when the channel current is reversed and greater than the alarm threshold, otherwise cleared.
0x0289	649	Channel 10 current reverse alarm status	This bit is set when the channel current is reversed and greater than the alarm threshold, otherwise cleared.
0x028A	650	Channel 11 current reverse alarm status	This bit is set when the channel current is reversed and greater than the alarm threshold, otherwise cleared.
0x028B	651	Channel 12 current reverse alarm status	This bit is set when the channel current is reversed and greater than the alarm threshold, otherwise cleared.
0x028C	652	Channel 13 current reverse alarm status	This bit is set when the channel current is reversed and greater than the alarm threshold, otherwise cleared.
0x028D	653	Channel 14 current reverse alarm status	This bit is set when the channel current is reversed and greater than the alarm threshold, otherwise cleared.
0x028E	654	Channel 15 current reverse alarm status	This bit is set when the channel current is reversed and greater than the alarm threshold, otherwise cleared.
0x028F	655	Channel 16 current reverse alarm status	This bit is set when the channel current is reversed and greater than the alarm threshold, otherwise cleared.
0x0290	656	Channel 17 current reverse alarm status	This bit is set when the channel current is reversed and greater than the alarm threshold, otherwise cleared.
0x0291	657	Channel 18 current reverse alarm status	This bit is set when the channel current is reversed and greater than the alarm threshold, otherwise cleared.
0x0292	658	Channel 19 current reverse alarm status	This bit is set when the channel current is reversed and greater than the alarm threshold, otherwise cleared.
0x0293	659	Channel 20 current reverse alarm status	This bit is set when the channel current is reversed and greater than the alarm threshold, otherwise cleared.
0x0294	660	Channel 21 current reverse alarm status	This bit is set when the channel current is reversed and greater than the alarm threshold, otherwise cleared.

0x0295	661	Channel 22 current reverse alarm status	This bit is set when the channel current is reversed and greater than the alarm threshold, otherwise cleared.
0x0296	662	Channel 23 current reverse alarm status	This bit is set when the channel current is reversed and greater than the alarm threshold, otherwise cleared.
0x0297	663	Channel 24 current reverse alarm status	This bit is set when the channel current is reversed and greater than the alarm threshold, otherwise cleared.
.....	.....	.....	.....
0x029F	671	Channel 32 current reverse alarm status	This bit is set when the channel current is reversed and greater than the alarm threshold, otherwise cleared.
0x02A0	672	Channel 1 no current alarm status	This bit is set to 1 when there is no current in this channel, otherwise cleared.
0x02A1	673	Channel 2 no current alarm status	This bit is set to 1 when there is no current in this channel, otherwise cleared.
0x02A2	674	Channel 3 no current alarm status	This bit is set to 1 when there is no current in this channel, otherwise cleared.
0x02A3	675	Channel 4 no current alarm status	This bit is set to 1 when there is no current in this channel, otherwise cleared.
0x02A4	676	Channel 5 no current alarm status	This bit is set to 1 when there is no current in this channel, otherwise cleared.
0x02A5	677	Channel 6 no current alarm status	This bit is set to 1 when there is no current in this channel, otherwise cleared.
0x02A6	678	Channel 7 no current alarm status	This bit is set to 1 when there is no current in this channel, otherwise cleared.
0x02A7	679	Channel 8 no current alarm status	This bit is set to 1 when there is no current in this channel, otherwise cleared.
0x02A8	680	Channel 9 no current alarm status	This bit is set to 1 when there is no current in this channel, otherwise cleared.
0x02A9	681	Channel 10 no current alarm status	This bit is set to 1 when there is no current in this channel, otherwise cleared.
0x02AA	682	Channel 11 no current alarm status	This bit is set to 1 when there is no current in this channel, otherwise cleared.
0x02AB	683	Channel 12 no current alarm status	This bit is set to 1 when there is no current in this channel, otherwise cleared.
0x02AC	684	Channel 13 no current alarm status	This bit is set to 1 when there is no current in this channel, otherwise cleared.

0x02AD	685	Channel 14 no current alarm status	This bit is set to 1 when there is no current in this channel, otherwise cleared.
0x02AE	686	Channel 15 no current alarm status	This bit is set to 1 when there is no current in this channel, otherwise cleared.
0x02AF	687	Channel 16 no current alarm status	This bit is set to 1 when there is no current in this channel, otherwise cleared.
0x02B0	688	Channel 17 no current alarm status	This bit is set to 1 when there is no current in this channel, otherwise cleared.
0x02B1	689	Channel 18 no current alarm status	This bit is set to 1 when there is no current in this channel, otherwise cleared.
0x02B2	690	Channel 19 no current alarm status	This bit is set to 1 when there is no current in this channel, otherwise cleared.
0x02B3	691	Channel 20 no current alarm status	This bit is set to 1 when there is no current in this channel, otherwise cleared.
0x02B4	692	Channel 21 no current alarm status	This bit is set to 1 when there is no current in this channel, otherwise cleared.
0x02B5	693	Channel 22 no current alarm status	This bit is set to 1 when there is no current in this channel, otherwise cleared.
0x02B6	694	Channel 23 no current alarm status	This bit is set to 1 when there is no current in this channel, otherwise cleared.
0x02B7	695	Channel 24 no current alarm status	This bit is set to 1 when there is no current in this channel, otherwise cleared.
.....	.....	.....	.....
0x02BF	703	Channel 32 no current alarm status	This bit is set to 1 when there is no current in this channel, otherwise cleared.
0x02C0	704	Channel 1 undercurrent alarm status	This bit is set to 1 when the channel is undercurrent, otherwise cleared.
0x02C1	705	Channel 2 undercurrent alarm status	This bit is set to 1 when the channel is undercurrent, otherwise cleared.
0x02C2	706	Channel 3 undercurrent alarm status	This bit is set to 1 when the channel is undercurrent, otherwise cleared.
0x02C3	707	Channel 4 undercurrent alarm status	This bit is set to 1 when the channel is undercurrent, otherwise cleared.
0x02C4	708	Channel 5 undercurrent alarm status	This bit is set to 1 when the channel is undercurrent, otherwise cleared.

0x02C5	709	Channel 6 undercurrent alarm status	This bit is set to 1 when the channel is undercurrent, otherwise cleared.
0x02C6	710	Channel 7 undercurrent alarm status	This bit is set to 1 when the channel is undercurrent, otherwise cleared.
0x02C7	711	Channel 8 undercurrent alarm status	This bit is set to 1 when the channel is undercurrent, otherwise cleared.
0x02C8	712	Channel 9 undercurrent alarm status	This bit is set to 1 when the channel is undercurrent, otherwise cleared.
0x02C9	713	Channel 10 undercurrent alarm status	This bit is set to 1 when the channel is undercurrent, otherwise cleared.
0x02CC	714	Channel 11 undercurrent alarm status	This bit is set to 1 when the channel is undercurrent, otherwise cleared.
0x02CB	715	Channel 12 undercurrent alarm status	This bit is set to 1 when the channel is undercurrent, otherwise cleared.
0x02CC	716	Channel 13 undercurrent alarm status	This bit is set to 1 when the channel is undercurrent, otherwise cleared.
0x02CD	717	Channel 14 undercurrent alarm status	This bit is set to 1 when the channel is undercurrent, otherwise cleared.
0x02CE	718	Channel 15 undercurrent alarm status	This bit is set to 1 when the channel is undercurrent, otherwise cleared.
0x02CF	719	Channel 16 undercurrent alarm status	This bit is set to 1 when the channel is undercurrent, otherwise cleared.
0x02D0	720	Channel 17 undercurrent alarm status	This bit is set to 1 when the channel is undercurrent, otherwise cleared.
0x02D1	721	Channel 18 undercurrent alarm status	This bit is set to 1 when the channel is undercurrent, otherwise cleared.
0x02D2	722	Channel 19 undercurrent alarm status	This bit is set to 1 when the channel is undercurrent, otherwise cleared.
0x02D3	723	Channel 20 undercurrent alarm status	This bit is set to 1 when the channel is undercurrent, otherwise cleared.
0x02D4	724	Channel 21 undercurrent alarm status	This bit is set to 1 when the channel is undercurrent, otherwise cleared.
0x02D5	725	Channel 22 undercurrent alarm status	This bit is set to 1 when the channel is undercurrent, otherwise cleared.
0x02D6	726	Channel 23 undercurrent	This bit is set to 1 when the channel is undercurrent, otherwise

		alarm status	cleared.
0x02D7	727	Channel 24 undercurrent alarm status	This bit is set to 1 when the channel is undercurrent, otherwise cleared.
.....	.....	.....	.....
0x02DF	735	Channel 32 undercurrent alarm status	This bit is set to 1 when the channel is undercurrent, otherwise cleared.
0x02E0	736	Channel 1 overcurrent alarm status	This bit is set to 1 when the channel is overcurrent, otherwise cleared.
0x02E1	737	Channel 2 overcurrent alarm status	This bit is set to 1 when the channel is overcurrent, otherwise cleared.
0x02E2	738	Channel 3 overcurrent alarm status	This bit is set to 1 when the channel is overcurrent, otherwise cleared.
0x02E3	739	Channel 4 overcurrent alarm status	This bit is set to 1 when the channel is overcurrent, otherwise cleared.
0x02E4	740	Channel 5 overcurrent alarm status	This bit is set to 1 when the channel is overcurrent, otherwise cleared.
0x02E5	741	Channel 6 overcurrent alarm status	This bit is set to 1 when the channel is overcurrent, otherwise cleared.
0x02E6	742	Channel 7 overcurrent alarm status	This bit is set to 1 when the channel is overcurrent, otherwise cleared.
0x02E7	743	Channel 8 overcurrent alarm status	This bit is set to 1 when the channel is overcurrent, otherwise cleared.
0x02E8	744	Channel 9 overcurrent alarm status	This bit is set to 1 when the channel is overcurrent, otherwise cleared.
0x02E9	745	Channel 10 overcurrent alarm status	This bit is set to 1 when the channel is overcurrent, otherwise cleared.
0x02EA	746	Channel 11 overcurrent alarm status	This bit is set to 1 when the channel is overcurrent, otherwise cleared.
0x02EB	747	Channel 12 overcurrent alarm status	This bit is set to 1 when the channel is overcurrent, otherwise cleared.
0x02EC	748	Channel 13 overcurrent alarm status	This bit is set to 1 when the channel is overcurrent, otherwise cleared.
0x02ED	749	Channel 14 overcurrent alarm status	This bit is set to 1 when the channel is overcurrent, otherwise cleared.

0x02EE	750	Channel 15 overcurrent alarm status	This bit is set to 1 when the channel is overcurrent, otherwise cleared.
0x02EF	751	Channel 16 overcurrent alarm status	This bit is set to 1 when the channel is overcurrent, otherwise cleared.
0x02F0	752	Channel 17 overcurrent alarm status	This bit is set to 1 when the channel is overcurrent, otherwise cleared.
0x02F1	753	Channel 18 overcurrent alarm status	This bit is set to 1 when the channel is overcurrent, otherwise cleared.
0x02F2	754	Channel 19 overcurrent alarm status	This bit is set to 1 when the channel is overcurrent, otherwise cleared.
0x02F3	755	Channel 20 overcurrent alarm status	This bit is set to 1 when the channel is overcurrent, otherwise cleared.
0x02F4	756	Channel 21 overcurrent alarm status	This bit is set to 1 when the channel is overcurrent, otherwise cleared.
0x02F5	757	Channel 22 overcurrent alarm status	This bit is set to 1 when the channel is overcurrent, otherwise cleared.
0x02F6	758	Channel 23 overcurrent alarm status	This bit is set to 1 when the channel is overcurrent, otherwise cleared.
0x02F7	759	Channel 24 overcurrent alarm status	This bit is set to 1 when the channel is overcurrent, otherwise cleared.
.....	.....	.....	.....
0x02FF	767	Channel 32 overcurrent alarm status	This bit is set to 1 when the channel is overcurrent, otherwise cleared.
0x0300	768	Channel 1 current low alarm state	This bit is set to 1 when the channel current is too low, otherwise cleared.
0x0301	769	Channel 2 current low alarm state	This bit is set to 1 when the channel current is too low, otherwise cleared.
0x0302	770	Channel 3 current low alarm state	This bit is set to 1 when the channel current is too low, otherwise cleared.
0x0303	771	Channel 4 current low alarm state	This bit is set to 1 when the channel current is too low, otherwise cleared.
0x0304	772	Channel 5 current low alarm state	This bit is set to 1 when the channel current is too low, otherwise cleared.
0x0305	773	Channel 6 current low alarm state	This bit is set to 1 when the channel current is too low, otherwise cleared.



0x0306	774	Channel 7 current low alarm state	This bit is set to 1 when the channel current is too low, otherwise cleared.
0x0307	775	Channel 8 current low alarm state	This bit is set to 1 when the channel current is too low, otherwise cleared.
0x0308	776	Channel 9 current low alarm state	This bit is set to 1 when the channel current is too low, otherwise cleared.
0x0309	777	Channel 10 current low alarm state	This bit is set to 1 when the channel current is too low, otherwise cleared.
0x030A	778	Channel 11 current low alarm state	This bit is set to 1 when the channel current is too low, otherwise cleared.
0x030B	779	Channel 12 current low alarm state	This bit is set to 1 when the channel current is too low, otherwise cleared.
0x030C	780	Channel 13 current low alarm state	This bit is set to 1 when the channel current is too low, otherwise cleared.
0x030D	781	Channel 14 current low alarm state	This bit is set to 1 when the channel current is too low, otherwise cleared.
0x030E	782	Channel 15 current low alarm state	This bit is set to 1 when the channel current is too low, otherwise cleared.
0x030F	783	Channel 16 current low alarm state	This bit is set to 1 when the channel current is too low, otherwise cleared.
0x0310	784	Channel 17 current low alarm state	This bit is set to 1 when the channel current is too low, otherwise cleared.
0x0311	785	Channel 18 current low alarm state	This bit is set to 1 when the channel current is too low, otherwise cleared.
0x0312	786	Channel 19 current low alarm state	This bit is set to 1 when the channel current is too low, otherwise cleared.
0x0313	787	Channel 20 current low alarm state	This bit is set to 1 when the channel current is too low, otherwise cleared.
0x0314	788	Channel 21 current low alarm state	This bit is set to 1 when the channel current is too low, otherwise cleared.
0x0315	789	Channel 22 current low alarm state	This bit is set to 1 when the channel current is too low, otherwise cleared.
0x0316	790	Channel 23 current low alarm state	This bit is set to 1 when the channel current is too low, otherwise cleared.

0x0317	791	Channel 24 current low alarm state	This bit is set to 1 when the channel current is too low, otherwise cleared.
.....	.....	.....	.....
0x031F	799	Channel 32 current low alarm state	This bit is set to 1 when the channel current is too low, otherwise cleared.
0x0320	800	Channel 1 current too high alarm state	This bit is set to 1 when the channel current is too high, otherwise cleared.
0x0321	801	Channel 2 current too high alarm state	This bit is set to 1 when the channel current is too high, otherwise cleared.
0x0322	802	Channel 3 current too high alarm state	This bit is set to 1 when the channel current is too high, otherwise cleared.
0x0323	803	Channel 4 current too high alarm state	This bit is set to 1 when the channel current is too high, otherwise cleared.
0x0324	804	Channel 5 current too high alarm state	This bit is set to 1 when the channel current is too high, otherwise cleared.
0x0325	805	Channel 6 current too high alarm state	This bit is set to 1 when the channel current is too high, otherwise cleared.
0x0326	806	Channel 7 current too high alarm state	This bit is set to 1 when the channel current is too high, otherwise cleared.
0x0327	807	Channel 8 current too high alarm state	This bit is set to 1 when the channel current is too high, otherwise cleared.
0x0328	808	Channel 9 current too high alarm state	This bit is set to 1 when the channel current is too high, otherwise cleared.
0x0329	809	Channel 10 current too high alarm state	This bit is set to 1 when the channel current is too high, otherwise cleared.
0x032A	810	Channel 11 current too high alarm state	This bit is set to 1 when the channel current is too high, otherwise cleared.
0x032B	811	Channel 12 current too high alarm state	This bit is set to 1 when the channel current is too high, otherwise cleared.
0x032C	812	Channel 13 current too high alarm state	This bit is set to 1 when the channel current is too high, otherwise cleared.
0x032D	813	Channel 14 current too high alarm state	This bit is set to 1 when the channel current is too high, otherwise cleared.
0x032E	814	Channel 15 current too high alarm state	This bit is set to 1 when the channel current is too high, otherwise cleared.

0x032F	815	Channel 16 current too high alarm state	This bit is set to 1 when the channel current is too high, otherwise cleared.
0x0330	816	Channel 17 current too high alarm state	This bit is set to 1 when the channel current is too high, otherwise cleared.
0x0331	817	Channel 18 current too high alarm state	This bit is set to 1 when the channel current is too high, otherwise cleared.
0x0332	818	Channel 19 current too high alarm state	This bit is set to 1 when the channel current is too high, otherwise cleared.
0x0333	819	Channel 20 current too high alarm state	This bit is set to 1 when the channel current is too high, otherwise cleared.
0x0334	820	Channel 21 current too high alarm state	This bit is set to 1 when the channel current is too high, otherwise cleared.
0x0335	821	Channel 22 current too high alarm state	This bit is set to 1 when the channel current is too high, otherwise cleared.
0x0336	822	Channel 23 current too high alarm state	This bit is set to 1 when the channel current is too high, otherwise cleared.
0x0337	823	Channel 24 current too high alarm state	This bit is set to 1 when the channel current is too high, otherwise cleared.
.....	.....	.....	.....
0x033F	831	Channel 32 current too high alarm state	This bit is set to 1 when the channel current is too high, otherwise cleared.

## Register description in word unit (function code 03 04 06)

Modbus address		Function description	Data Type	instruction	R/W
Hex	Decimal				
Address 0x0100 ~ 0x0158, a total of 89 consecutive addresses					
Address 0x0100 ~ 0x0123, a total of 36 consecutive addresses (data in this address supports data freeze)					
0x0100	256	Broadcast time-year, month	Unsigned short	Keep to the next broadcast, high 8 digits: year (2000+), low 8 digits: month	R
0x0101	257	Broadcast time-day, hour	Unsigned short	Keep to the next broadcast, high 8 digits: day, low 8 digits: hour	R
0x0102	258	Broadcast time-minutes, seconds	Unsigned short	Keep to the next broadcast, high 8 digits: minute, low 8 digits: second	R
0x0103	259	Retain			
0x0104	260	bus voltage	Unsigned short	Unit V, default 0	R
0x0105	261	Temperature sensor 1	short	Unit: 0.1 ° C, default -500	R
0x0106	262	Temperature sensor 2	short	Unit: 0.1 ° C, default -500	R
0x0107	263	Switch input	Unsigned short	bit0: DI1, bit1: DI2, bit2: DI3, bit3: DI4 0: open, 1: closed, default 0	R
0x0108	264	Quantity of online Hall channels	Unsigned short	Shows the quantity of Hall channels currently connected. default 0	R
0x0109	265	Total reverse current	short	Unit is 10mA, default is 0	R
0x010A	266	Total current	Short	Unit is 10mA, default is 0,	R
0x010B	267	Average current	Short	Unit mA, default 0	
0x010C ~ 0x012B	268 ~ 299	Channel 1 to 32 current	Short	Unit mA, default 0	R
0x012D	301	Alarm status 1	Unsigned short	Bit0 bus arc, bit1 channel arc, bit2 low voltage, bit3 high voltage, bit4 high temperature 1, bit5 high temperature 2, bit6 channel current value is reversed bit7 reverse total current is high, bit8 total current is low, bit9 total current is high, bit10 channel current value is zero, bit11 channel current value undercurrent bit12 channel current value overcurrent bit13 channel current value is low	R

				bit14 channel current value is high 0: No alarm, 1: Alarm, default 0	
0x014B	331	Channel 1 ~ 16 reverse current alarm	Unsigned short	Default 0 0: No alarm, 1: Alarm	R
0x014C	332	Channel 17 ~ 32 reverse current alarm	Unsigned short	Default 0 0: No alarm, 1: Alarm	R
0x014D	333	Channel 1 ~ 16 no current alarm	Unsigned short	Default 0 0: No alarm, 1: Alarm	R
0x014E	334	Channel 17 ~ 32 no current alarm	Unsigned short	Default 0 0: No alarm, 1: Alarm	R
0x014F	335	Channel 1 ~ 16 undercurrent alarm	Unsigned short	Default 0 0: No alarm, 1: Alarm	R
0x0150	336	Channel 17 ~ 32 undercurrent alarm	Unsigned short	Default 0 0: No alarm, 1: Alarm	R
0x0151	337	Channel 1 ~ 16 overcurrent alarm	Unsigned short	Default 0 0: No alarm, 1: Alarm	R
0x0152	338	Channel 17 ~ 32 overcurrent alarm	Unsigned short	Default 0 0: No alarm, 1: Alarm	R
0x0153	339	Channel 1 ~ 16 current low alarm	Unsigned short	Default 0 0: No alarm, 1: Alarm	R
0x0154	340	Channel 17 ~ 32 current low alarm	Unsigned short	Default 0 0: No alarm, 1: Alarm	R
0x0155	341	Channel 1 ~ 16 current high alarm	Unsigned short	Default 0 0: No alarm, 1: Alarm	R
0x0156	342	Channel 17 ~ 32 current high alarm	Unsigned short	Default 0 0: No alarm, 1: Alarm	R

The address 0x0200 ~ 0x02FF, which has a total of 128 consecutive addresses. It is recommended to read in sections.

### **Power information (0x0200-0x024b)**

0x0200	512	Total power	Unsigned short	Unit is 100W, default is 0	R
0x0201	513	Average power	Unsigned short	Unit W, default 0	R
0x0202 ~ 0x0221	514 ~ 545	Channel 1 ~ 32 power	Unsigned short	Unit W, default 0	R
0x0222	546	The higher 16bit of the total generated energy	Unsigned short	Unit Wh, default 0	R
0x0223	547	The lower 16bit of the total generated energy	Unsigned short	Unit Wh, default 0	R
0x0224	548	The higher 16bit of the generated energy of channel1	Unsigned short	Unit Wh, default 0	R
0x0225	549	The lower 16bit of the generated energy of	Unsigned short	Unit Wh, default 0	R

		channel1			
.....	.....	.....	.....	.....	.....
0x0262	610	The higher 16bit of the generated energy of Channel 32	Unsigned short	Unit Wh, default 0	R
0x0263	611	The lower 16bit of the generated energy of Channel 32	Unsigned short	Unit Wh, default 0	R
<b>System information configuration (0x0B00-0x0B24)</b>					
0x0B00	2816	Alarm release	Unsigned Short	The percentage of the alarm threshold is used as the alarm release threshold. Unit %, default 2, setting range 0 to 100	W/R
0x0B01	2817	Bus voltage alarm low threshold	Unsigned short	Unit V, default 300	W/R
0x0B02	2818	Bus voltage alarm high threshold	Unsigned short	Unit V, default 1000	W/R
0x0B03	2819	Temperature sensor 1 alarm high threshold	short	Unit 0.1 ° C, default 800, setting range is greater than -400	W/R
0x0B04	2820	Temperature sensor 2 alarm high threshold	short	Unit 0.1 ° C, default 800, setting range is greater than -400	W/R
0x0B05	2821	Total current low alarm threshold	Unsigned Short	Unit 10mA, default 1600, (take 16 channels to calculate)	W/R
0x0B06	2822	Total current too high alarm threshold	Unsigned Short	Unit 10mA, default 1600, (take 16 channels to calculate)	W/R
0x0B07	2823	Current channel related alarm activation threshold	Unsigned Short	Unit mA, default 2000. The average current value is greater than this value; the total current is too high, too low, the channel is undercurrent, overcurrent, no current, high current, low current, otherwise these alarms will be forcibly turned off.	W/R
0x0B08	2824	Undercurrent, overcurrent alarm threshold	Unsigned short	Unit mA, default 2000. The average current is subtracted from this value as the undercurrent alarm threshold; the average current is added to this value as the overcurrent alarm threshold.	W/R
0x0B09	2825	Channel current low alarm threshold	Unsigned short	Unit mA, default 1000.	W/R
0x0B0A	2826	Channel current high alarm threshold	Unsigned short	Unit mA, default 10000.	W/R
0x0B0B	2827	Reverse total current too high threshold	short	Unit 10mA, default -600.	W/R
0x0B0C	2828	Channel reverse current too high threshold	short	Unit mA, default -2000.	W/R

0x0B0D	2839	-	-	-	
0x0B0E	2830	Channel arc intensity super high alarm threshold	Short	The default is 70. Need to set according to the site conditions or customer requirements, you can call the company's technical staff	W/R
0x0B0F	2831	Retain			
0x0B10	2832	Retain			
0x0B11	2833	Automatic current calibration setting	Bool	Write 1 to enable automatic current calibration, write 0 to disable, default is 0	W/R
0x0B12	2834	Manual current calibration setting	Bool	Write 1 to start current calibration, write 0 to turn off, default is 0 Note: Make sure the channel has no current when starting calibration.	W/R
0x0B13	2835	Channel 1~16 current channel switch setting	Unsigned short	bit0: Represents the switch setting for channel 1 bit15: Represents the switch setting for channel 16 0 means disabled, 1 means enabled Default 0xFFFF	W/R
0x0B14	2836	Channel 17~32 current channel switch setting	Unsigned short	bit0: Represents the switch setting for channel 7 bit7: Represents the switch setting for channel 24 0 means disabled, 1 means enabled Default 0xFFFF	W/R
0x0B15	2837	External power management time setting	Unsigned short	Unit M (min), default 120 minutes. When the photovoltaic power supply stops, the host can be powered by external 24 power sources, and the power supply time can be set.	W/R
0x0B16	2838	Current UI display, direction, reverse order control	Unsigned short	Bit0 ~ bit1: Y-axis scale setting of UI interface 0 means the UI interface displays the current up to 10A 1 means the UI interface displays the current up to 20A 2 means the UI interface displays a maximum current of 30A bit2: current channel forward / reverse sequence setting (Positive sequence: 1 ~ 24 channels arranged near the host Hall; Reverse order: Calculate from 24 to 1 channel near the host Hall)	W/R

				0 means positive order; 1 means reverse order bit3: Channel current direction setting 0 means the direction is positive, 1 means the current is reversed. 0x0000 by default;	
0x0B17	2839	Retain			
0x0B20	2848	Alarm function management 1	Unsigned short	Bit0 Bus arc, bit1 Channel arc, bit2 Low pressure, bit3 Over pressure, bit4 High temperature 1, bit5 High temperature 2, bit6 Channel current value is reversed, bit7 Reverse total current is high, bit9 The total current is high, bit10 Channel current value is zero, bit11 Channel current value is undercurrent, bit12 Channel current value is overcurrent, bit13 The channel current value is low, bit14 The channel current value is high, 1: enable (open) alarm, 0: disable(close) alarm Default: 0x0003	W/R
0x0B21	2849	Alarm function management 2	Unsigned short	Bit0 DI1 bit1 DI2 bit2 DI3 bit3 DI4 bit14: - bit15: General alarm switch, (function is forcibly turned on) 1: enable alarm, 0: disable alarm Default value: 0x800F	W/R
0x0B23	2851	Retain			
0x0B24	2852	Retain			
<b>System information configuration 2 (0x0C00-0x0C06)</b>					W/R
0x0C00	3072	Clear power generation history value record	Unsigned short	Write 1 reset energy history record, read always 0	W/R
<b>System settings (0xFE00-0xFE54)</b>					
0xFE00	65024	Modbus address	Unsigned short	Set range 1 ~ 247, default 247. Set other values to restore the default	W/R



				values.	
0xFE01	65025	Modbus Baud rate	Unsigned short	1: 2400, 2: 4800, 3: 9600, 4: 19200, 5: 38400 Default is 3	W/R
0xFE02	65026	Modbus Parity	Unsigned short	0: NONE, 1: ODD, 2: EVEN Default is 0	W/R

## FAQ

Troubleshooting for screen flicker (Please refer to page 3 of the manual to deal with the problem of excessive interference from shielded wires)

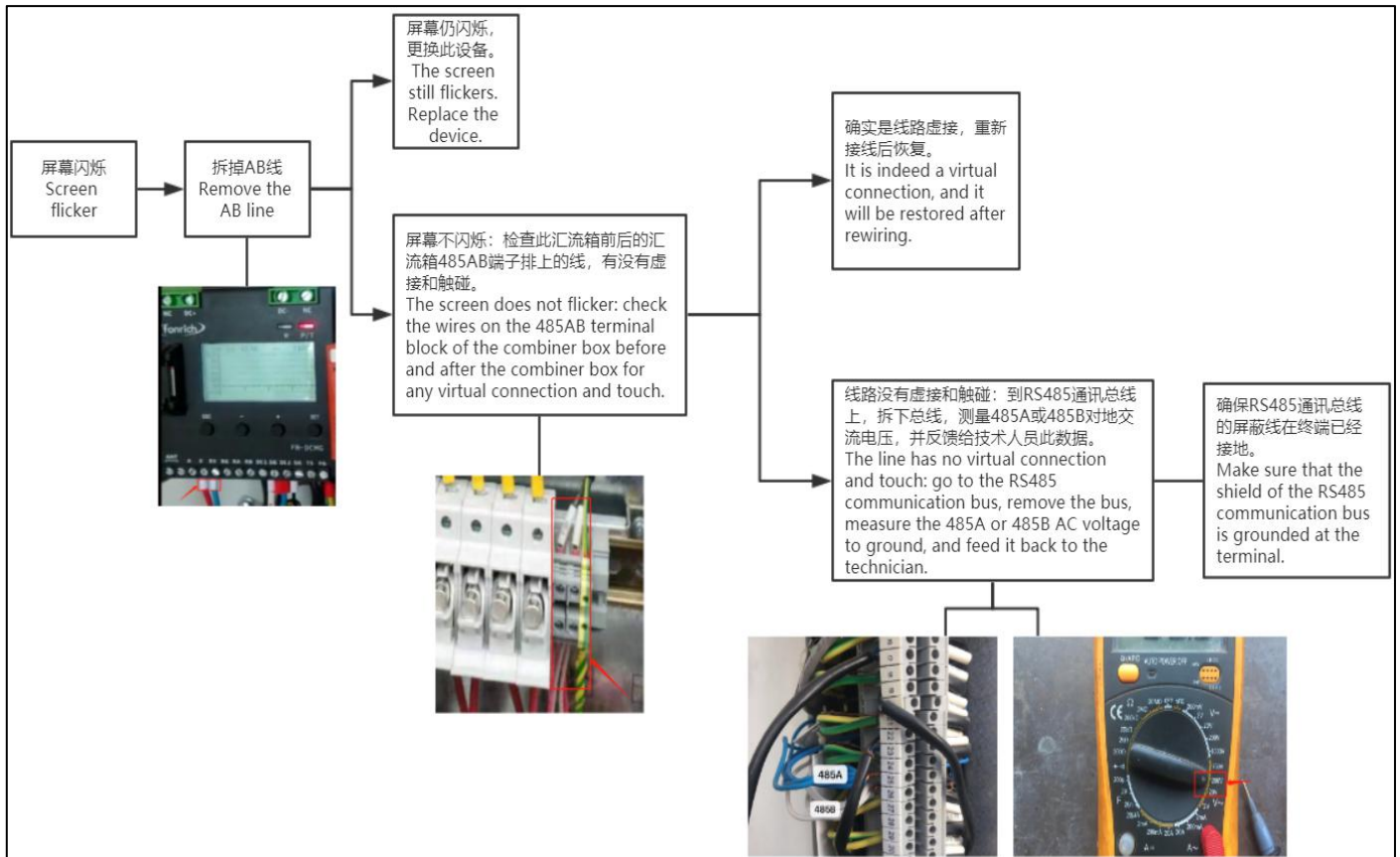

## Document revision record

Revision	Time	Description
3.1	2016-4-16	1. Add the alarm recording function of trip failure; 2. Receive background authorization; 3. Support to read the log through Modus.
3.2	2016-5-03	1. Realize automatic allocation of address; 2. Add data freezing function; 3. Add broadcasting function.
3.3	2016-6-19	1. The peak current range of the interface can be set to 10A, 20A and 30A by modifying the bar graph. 2. Increase the frequency of statistical arc alarm. 3. Add the function of log clearance, which can be removed manually or by Modbus.
3.4	2017-7-14	1. Add component status detection 2. Update the software version number
3.8	2018-4-12	Update the internal register list
3.9	2019-12-26	Update register description, switch alarm description
4.0	2020-01-13	Update the switch value description, new program interface and alarm interface; New-Current calibration function, interface and register ——Arc intensity 10 minutes value register ——High/low level switching function, interface and register in trip mode ——Arc Alarm Strategy Deletion-broadcast, battery board and other registers
4.1	2020-04-14	For A025 and above products Update switch description, terminal definition, new setting interface and alarm interface; Add ——Arc Intensity 10 Minute Value Register ——Arc Alarm Strategy ——Communication shielded wire wiring specification ——Current calibration function, interface and register

		<p>—FAQ (screen flicker troubleshooting method)</p> <p>—Controller connection diagram</p> <p>Deletion-Broadcast, battery board and other registers</p>
4.2	2020-07-06	<p>For A028 and above products</p> <p>Add</p> <p>—HS4Q large range registers 0x0400, 0x0500</p>
	2020-07-20	<p>Register update suitable for FR-DCMG-MMPY products</p>

## Contact us

If you have any questions about this product, please contact us. Please remember the following contact information:

Fonrich (Shanghai) New Energy Technology Co., Ltd.

Add: 1st Floor, Building 5, No.999 Jiangyue Road, Minhang District, Shanghai

Zip code: 201114 Tel :+86 21 61679672

Fax:+86 21 60717306 Email: [sales@fonrich.com](mailto:sales@fonrich.com)

Website: [www.fonrich.com](http://www.fonrich.com)