



User Manual

Version 4.6

DC System Monitor: FR-DCMG-MMPU



丰郅（上海）新能源科技有限公司
Fonrich (Shanghai) New Energy Technology Co., Ltd.

Add: 1st Floor, Building 5, No.999 Jiangyue Road, Minhang District, Shanghai
Web: www.fonrich.com
Tel: +86 21 61679671
Email: sales@fonrich.com

Table of Contents

Table of Contents	1
Product description	2
The main function.....	2
Document Note:.....	2
Terminals Definition.....	3
RS485 Cable Connection, Shielding, and Grounding.....	4
Operation interface display	5
Button Key Operation.....	5
Indication Leds.....	5
Histogram Interface.....	5
Channel current and power generation display interface.....	6
Parameter setting interface.....	7
Current calibration setting interface.....	7
Software version number display interface.....	8
Alarm status display interface.....	8
Channel arc fault alarm interface.....	8
Fault alarm clear interface.....	9
Items that can generate alarms can be set.....	9
Alarm conditions.....	10
Alarm message.....	10
MODBUS Protocol definition	11
Communication format configuration.....	11
Data frame format description (refer to Modbus RTU standard).....	11
Data message example.....	11
Function code description.....	12
Register description.....	12
Register description in bit units (function code 02).....	12
Register description in word unit (function code 03 04 06).....	25
Appendix	32
Document revision record.....	32
Contact us	34

Product description

FR-DCMG DC monitor products are mainly used in DC transmission, power distribution and other occasions, such as photovoltaic combiner boxes, DC cabinets, telecommunication equipment rooms and communication base stations. Through RS485 or industrial wireless communication with the host computer, its main functions include real-time monitoring of the current of each branch in the DC system, bus voltage, box temperature, lightning protector status, and DC circuit breaker status. It can realize automatic alarm for abnormal conditions and real-time detection of whether there is a harmful arc in the DC circuit.

The main function

- Monitoring function: real-time monitoring of the generation current, voltage, temperature of the combiner box, lightning arrester status, DC circuit breaker status and DC arc fault status of each photovoltaic string in the combiner box, and communicate with the host computer through RS485.
- Display content: For the detected voltage, current, temperature, switch status, power generation and other data, FR-DCMG-MMPU can display histogram interface through LCD, and read current and other data more intuitively.
- Alarm function: According to the actual needs of the site, the alarm can be configured to turn on or off, and the interface will pop up the alarm information when the alarm is triggered.
- Current calibration: Identify zero drift and improve the accuracy of current identification. (Default closed)
- Compatibility: Program compatible model FR-DCMG-MMPD products

Document Note:

- This manual is applicable to the monitoring host whose model is FR-DCMG-MMPU and the software version is A029 and above. See page 10 for the version view method

Terminals Definition

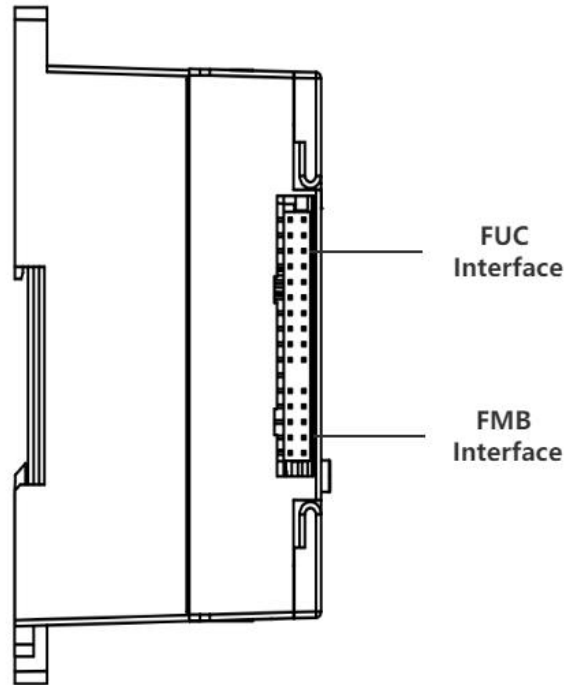
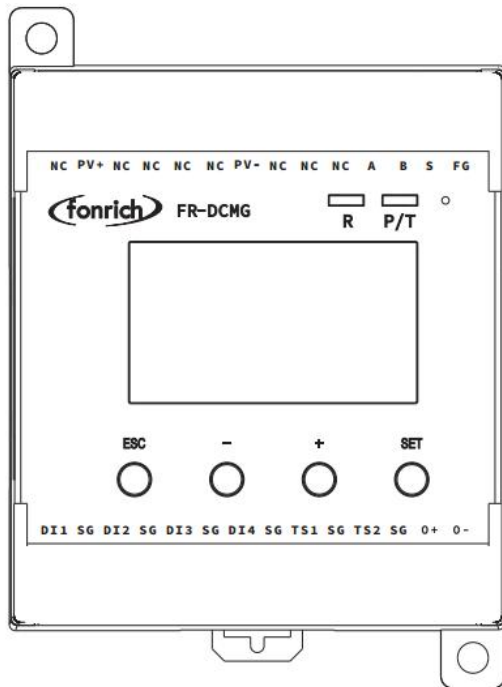

Symbol	Meaning
PV+ /PV-	PV DC bus power supply terminal
NC	Not connecion
S	Not connecion
A.B	RS485 Communication terminal
FG	Fixed Ground terminal
TS1/TS2	Externally connected temperature sensor terminals
SG	Temperature sensor and digital input ground terminal
DI1/DI2/DI3/DI4	4 digital input terminals
FUC	Can connect modules with FUC interface
FMB	Modules with an FMB interface can be connected, such as the FR-DCMG-AS4A DC Arc Detector.

RS485 Cable Connection, Shielding, and Grounding

The FG terminal of the FR-DCMG must be grounded, otherwise communication will interfere and the reliability of the device will decrease. The grounding wire should be grounded nearby. The grounding wire should be no more than 15cm from the "FG" terminal to the bottom of the combiner box. It is recommended to be within 10cm. The shorter the better, the thicker the better. The bottom of the combiner box should be connected to the ground. The main control unit module is fixed on a standard guide rail with a width of 3.5 cm.

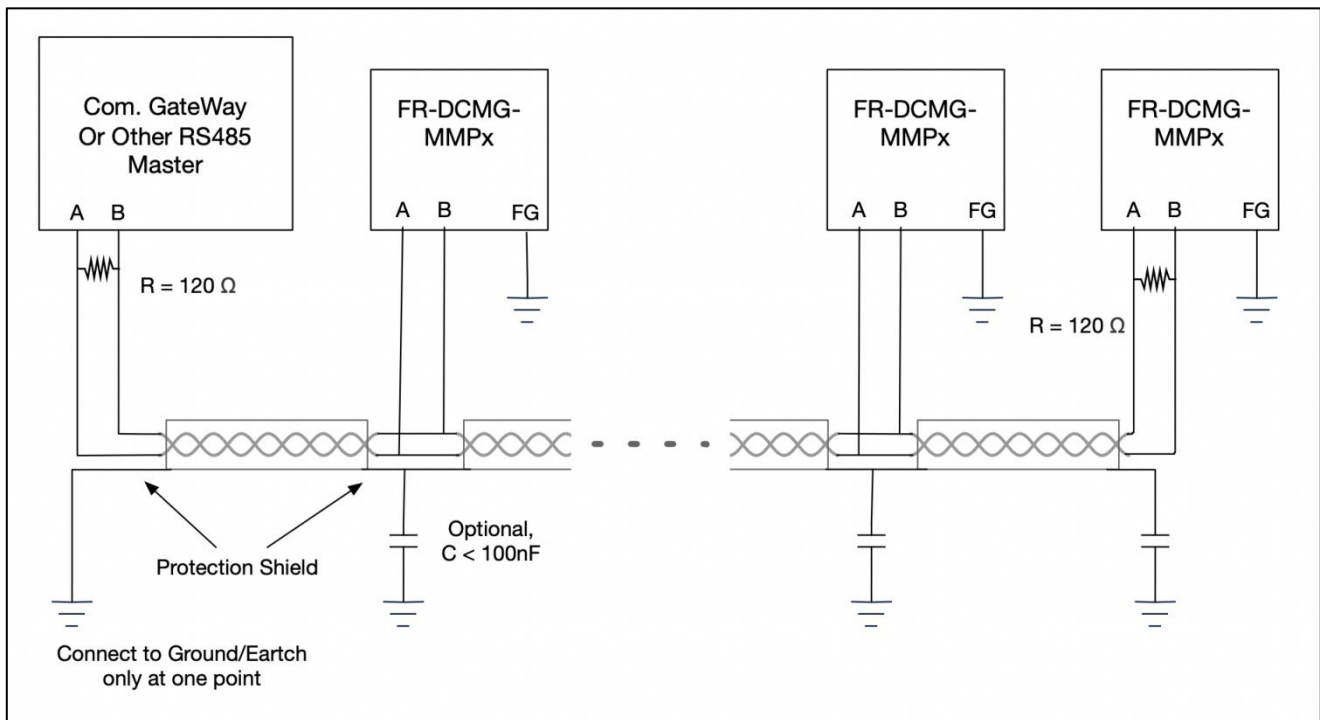

The wiring specifications of the communication shielded wire are shown in the figure above:

The wiring of on-site communication lines requires that the communication shield can only be grounded at a single point, otherwise there will be a risk of lightning surge damage to all equipment on the entire communication line during a lightning strike;

If you encounter a situation where communication line interference is too large to communicate, you can refer to the figure above, and insert a high voltage capacitor $C < 100nF$ between the shielded wire of each combiner box and the ground wire, and use this capacitor to filter the shielding layer interference.

Operation interface display

Button Key Operation

FR-DCMG-MMPU has four keys "ESC" , "-" , "+" , and "SET" .

"ESC" key is used to return to the default interface and cancel parameter setting;

"SET" key is used to enter the parameter setting mode, select the parameter to be set and complete the setting of the parameter;

The "+" and "-" keys are used to scroll the screen and adjust parameters;

Press the "+" and "-" keys at the same time to display the software version interface;

Press the "ESC" and "-" keys simultaneously to display the current calibration interface;

If there is no key operation for 10 seconds, the interface will automatically jump to the default interface of the current mode, and the brightness will decrease after 5 seconds.

Indication Leds

The factory default of the device is Modbus mode. When the host computer is connected to the device via RS485 and communicates, the LED lights "R" and "P/T" will flash alternately to indicate that the communication is normal. When the device is not connected to the communication, it will restart every 5 minutes by default. You can also turn off the default restart function by writing 0 to the 0xF003 register.

Histogram Interface

The histogram interface is the default display interface of Modbus mode, as shown below:

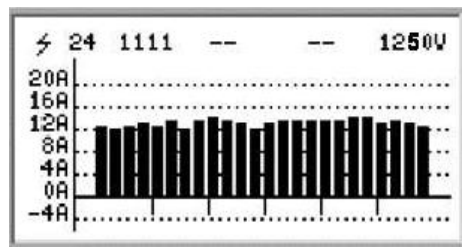

The histogram in the figure shows the current value detected by each channel. The display range of the initial interface is: -4A~20A, and the maximum range can also be

modified to 30A, 40A by setting register 0x0B16. Since it is connected to a six-channel Hall sensor, every six channels are distinguished when displaying. The current channels are channel 1~24 from left to right, and the order of the current channels can also be set in reverse order. The lightning icon in the upper left corner indicates that the Hall sensor connected to the horn of FR-DCMG-MMPU has arc monitoring function; "24" indicates the current number of online arc and current channels; "1111" indicates the real-time status of digital inputs DI1~DI4; "1250V" indicates the real-time voltage value of the bus. If there is no key operation within 5 seconds, the screen brightness will decrease.

Channel current and power generation display interface

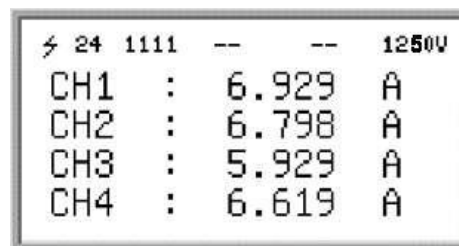

In the histogram mode, press the "+" or "-" key to enter the channel current and power generation display interface. The current value and cumulative power generation of each channel are displayed on the screen. When the "+" key is pressed first, the digital value of the current is displayed first, and when the "-" is pressed first, the cumulative power generation value is displayed first. When viewing the current and cumulative power generation value, you can continue to press the "+" or "-" key to scroll through the screen. After the current display is over, continue to press the "+" key to start displaying the cumulative power generation. The picture above is the current display interface. "CH1:" in the above figure indicates that the real-time monitoring current value of channel 1 is "6.929A", and so on.

The figure below shows the cumulative power generation display interface. "CH1:" in the figure indicates that the cumulative power generation of channel 1 is "6.929kwh", and so on.

⚡ 24	1111	--	--	1250W
CH1	:	6.929	KWh	
CH2	:	6.798	KWh	
CH3	:	5.929	KWh	
CH4	:	6.619	KWh	

Parameter setting interface

In the histogram interface, press the "SET" key to enter the Modbus parameter setting interface. The Modbus parameter setting is as follows:

Device Setting	
ADDR	: 247
PAR	: None
BPS	: 9600

- ADDR: The communication address of the Modbus slave node, the range is 1 ~ 247 (default is 247).
- PAR: The data verification method of Modbus communication. The optional parity (None), odd parity (Odd), even parity (Even), and no parity by default.
- BPS: Baud rate for Modbus communication. The selectable baud rates are 2400, 4800, 9600 (default), 19200, 38400.

Current calibration setting interface

Press the "ESC" and "-" keys at the same time to enter the current calibration setting interface, as shown below:

CALIBRATE	
AUTO OFF	
MUNUAL OFF	

To use this feature, please contact the company's technical support staff.

Software version number display interface

In the histogram interface, press the "+" and "-" keys at the same time to enter the software version number display interface, as shown below:

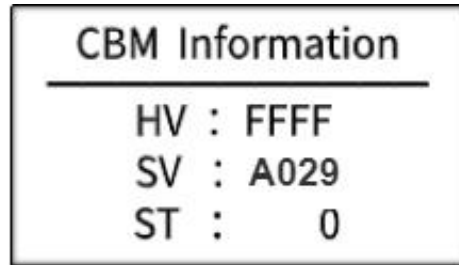

- HV: Keep
- SV: Software version number
- ST: Keep

Alarm status display interface

Alarm messages can be cleared remotely and manually. Manual clearing requires long-pressing the host's "ESC" key for 2 seconds, remote clearing requires writing "1" to register 0x0079 to clear. If an arc alarm occurs, it must be cleared manually or remotely. Restarting the host will still display the alarm message.

Channel arc fault alarm interface

After the DC arc sensor detects the occurrence of a fault arc, the alarm information interface of the host is as shown below.

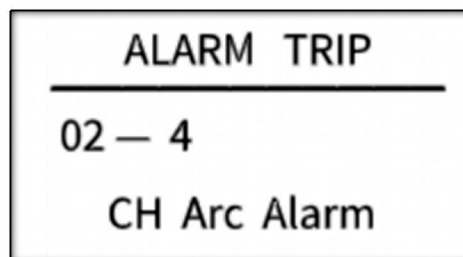

In the figure above: "02" means channel arc fault alarm, and "4" means that the fault arc alarm channel is 4.

Fault alarm clear interface

The host sends an alarm when it detects a fault, and the user can choose to handle it locally or remotely. By long-pressing the "ESC" key for about 2 seconds locally, the system jumps out of the interface as shown below, indicating that the alarm status has been cleared; remote processing needs to write "1" to 0x0079 to clear, and the interface shown below will be displayed after clearing successfully.

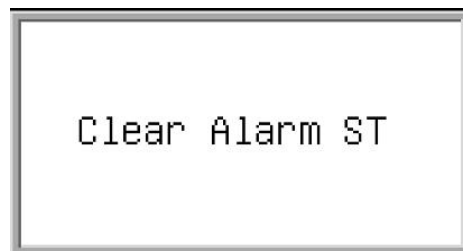

Items that can generate alarms can be set

- Voltage is too high
- Voltage is too low
- Temperature is too high
- Channel reverse current
- Total reverse current is too high
- Total current is too high
- Total current is too low
- Channel without current
- Low channel current
- High channel current
- Channel current value undercurrent
- Channel current value overcurrent
- Lightning Arrester Status (DI1)
- circuit breaker status (DI2)

Switch DI3 status

Switch DI4 status

Alarm conditions

Current reverse, no current, under current, over current, low current, high current, etc.

- a. Only when the average value of the channel current is greater than the set alarm threshold of the current channel, the alarm function of the above current-related items is activated; otherwise, the alarm status is forcibly cleared to 0.
- b. As for whether the alarm needs to be separately met the respective alarm conditions (above or below the respective alarm threshold).
- c. Check if the corresponding alarm register is open, closed by default

Alarm message

- Undercurrent alarm. After the channel average current value is subtracted from the overcurrent / undercurrent alarm threshold, the current value is still less than or equal to the current channel start alarm start threshold. The overcurrent / undercurrent alarm threshold will change as the average current changes.
- Over current alarm. After the channel average current value plus the over current / under current alarm threshold, the current value is still greater than or equal to the current channel start alarm start threshold. The over current / under current alarm threshold will change as the average current changes.
- Low current alarm, when the current is less than or equal to the channel current low alarm threshold, an alarm occurs.
- High current alarm. When the current is greater than or equal to the channel current high alarm threshold, an alarm occurs.
- No current alarm, when the absolute value of the current is less than 250mA, an alarm occurs.

Message example analysis: The above sending message reads the value of slave address 1 and register address 0x0104 (voltage V), and the received message responds with voltage data 0x02BC, which is converted to decimal, which is 700V.

Function code description

Register reads and writes in bits

- Function code 01 used to read the contents of the bit register
- Function code 02 used to reads the contents of the bit register
- Function code 05 used to write single bit-type registers

The contents represented by the register in bits are: switch value, alarm information, etc.

Register read and write in word units

- Function codes 03、 04 are used to read multiple word-type registers
- Function code 06 is used to write single word-type registers
- Function code 16 is used to multiple word-type registers

The content of the word-type registers can be voltage, current, generated energy, etc

Register description

Register description in bit units (function code 02)

Bit address		Functional description	remark
Hex	Decimal		
0x021E	542	-	-
0x0230	560	-	-
0x0231	561	Channel arc alarm status	This bit is set when the channel arc strength is above the alarm threshold. Clear the alarm and set it to 0.

0x0232	562	Bus voltage too low alarm status	This bit is set when the bus voltage is below the alarm threshold. Cleared below the alarm release threshold
0x0233	563	Bus voltage to high alarm status	This bit is set when the bus voltage exceeds the alarm threshold. Cleared below the alarm release threshold
0x0234	564	Temperature sensor 1 high temperature alarm status	This bit is set when the temperature sensor 1 temperature exceeds the alarm threshold. Cleared below the alarm release threshold
0x0235	565	Temperature sensor 2 high temperature alarm status	This bit is set when the temperature sensor 2 temperature exceeds the alarm threshold. Cleared below the alarm release threshold
0x0236	566	Channel reverse current alarm status	When the reverse current is generated in the channel, the position is 1, and the alarm is cleared.
0x0237	567	Total reverse current alarm status	This bit is set when the total reverse current exceeds the alarm threshold. Cleared below the alarm release threshold
0x0238	568	Total current too low alarm state	This bit is set when the total current exceeds the alarm threshold. Cleared below the alarm release threshold
0x0239	569	Total current too high alarm state	This bit is set when the total current exceeds the alarm threshold. Cleared below the alarm release threshold
0x023A	570	Channel current value zero	The channel has no current alarm and this bit is set to 1.
0x023B	571	Channel current value undercurrent	Channel undercurrent alarm, this bit is set to 1
0x023C	572	Channel current value overcurrent	Channel overcurrent alarm, this bit is set to 1.
0x023D	573	Channel current value is too low	Channel current low alarm, this bit is set to 1
0x023E	574	Channel current value is too high	Channel current high alarm, this bit is set to 1
0x0240	576	Switch 1 alarm status	The state of the device's input switch DI1, 0: open, 1: closed
0x0241	577	Switch 2 alarm status	The state of the device's input switch DI2, 0: open, 1: closed
0x0242	578	Switch 3 alarm status	The state of the device's input switch DI3, 0: open, 1: closed
0x0243	579	Switch 4 alarm status	The state of the device's input switch DI4, 0: open, 1: closed
.....

0x0260	608	Channel 1 arc alarm status	When the arc intensity of the channel is greater than the alarm threshold, this bit is set to 1; after clearing the alarm, it is set to 0
0x0261	609	Channel 2 arc alarm status	When the arc intensity of the channel is greater than the alarm threshold, this bit is set to 1; after clearing the alarm, it is set to 0
0x0262	610	Channel 3 arc alarm status	When the arc intensity of the channel is greater than the alarm threshold, this bit is set to 1; after clearing the alarm, it is set to 0
0x0263	611	Channel 4 arc alarm status	When the arc intensity of the channel is greater than the alarm threshold, this bit is set to 1; after clearing the alarm, it is set to 0
0x0264	612	Channel 5 arc alarm status	When the arc intensity of the channel is greater than the alarm threshold, this bit is set to 1; after clearing the alarm, it is set to 0
0x0265	613	Channel 6 arc alarm status	When the arc intensity of the channel is greater than the alarm threshold, this bit is set to 1; after clearing the alarm, it is set to 0
0x0266	614	Channel 7 arc alarm status	When the arc intensity of the channel is greater than the alarm threshold, this bit is set to 1; after clearing the alarm, it is set to 0
0x0267	615	Channel 8 arc alarm status	When the arc intensity of the channel is greater than the alarm threshold, this bit is set to 1; after clearing the alarm, it is set to 0
0x0268	616	Channel 9 arc alarm status	When the arc intensity of the channel is greater than the alarm threshold, this bit is set to 1; after clearing the alarm, it is set to 0
0x0269	617	Channel 10 arc alarm status	When the arc intensity of the channel is greater than the alarm threshold, this bit is set to 1; after clearing the alarm, it is set to 0
0x026A	618	Channel 11 arc alarm status	When the arc intensity of the channel is greater than the alarm threshold, this bit is set to 1; after clearing the alarm, it is set to 0
0x026B	619	Channel 12 arc alarm status	When the arc intensity of the channel is greater than the alarm threshold, this bit is set to 1; after clearing the alarm, it is set to 0
0x026C	620	Channel 13 arc alarm status	When the arc intensity of the channel is greater than the alarm threshold, this bit is set to 1; after clearing the alarm, it is set to 0

			0
0x026D	621	Channel 14 arc alarm status	When the arc intensity of the channel is greater than the alarm threshold, this bit is set to 1; after clearing the alarm, it is set to 0
0x026E	622	Channel 15 arc alarm status	When the arc intensity of the channel is greater than the alarm threshold, this bit is set to 1; after clearing the alarm, it is set to 0
0x026F	623	Channel 16 arc alarm status	When the arc intensity of the channel is greater than the alarm threshold, this bit is set to 1; after clearing the alarm, it is set to 0
0x0270	624	Channel 17 arc alarm status	When the arc intensity of the channel is greater than the alarm threshold, this bit is set to 1; after clearing the alarm, it is set to 0
0x0271	625	Channel 18 arc alarm status	When the arc intensity of the channel is greater than the alarm threshold, this bit is set to 1; after clearing the alarm, it is set to 0
0x0272	626	Channel 19 arc alarm status	When the arc intensity of the channel is greater than the alarm threshold, this bit is set to 1; after clearing the alarm, it is set to 0
0x0273	627	Channel 20 arc alarm status	When the arc intensity of the channel is greater than the alarm threshold, this bit is set to 1; after clearing the alarm, it is set to 0
0x0274	628	Channel 21 arc alarm status	When the arc intensity of the channel is greater than the alarm threshold, this bit is set to 1; after clearing the alarm, it is set to 0
0x0275	629	Channel 22 arc alarm status	When the arc intensity of the channel is greater than the alarm threshold, this bit is set to 1; after clearing the alarm, it is set to 0
0x0276	630	Channel 23 arc alarm status	When the arc intensity of the channel is greater than the alarm threshold, this bit is set to 1; after clearing the alarm, it is set to 0
0x0277	631	Channel 24 arc alarm status	When the arc intensity of the channel is greater than the alarm threshold, this bit is set to 1; after clearing the alarm, it is set to 0
.....
0x0280	640	Channel 1 current reverse	This bit is set when the channel current is reversed and greater

		alarm status	than the alarm threshold, otherwise cleared.
0x0281	641	Channel 2 current reverse alarm status	This bit is set when the channel current is reversed and greater than the alarm threshold, otherwise cleared.
0x0282	642	Channel 3 current reverse alarm status	This bit is set when the channel current is reversed and greater than the alarm threshold, otherwise cleared.
0x0283	643	Channel 4 current reverse alarm status	This bit is set when the channel current is reversed and greater than the alarm threshold, otherwise cleared.
0x0284	644	Channel 5 current reverse alarm status	This bit is set when the channel current is reversed and greater than the alarm threshold, otherwise cleared.
0x0285	645	Channel 6 current reverse alarm status	This bit is set when the channel current is reversed and greater than the alarm threshold, otherwise cleared.
0x0286	646	Channel 7 current reverse alarm status	This bit is set when the channel current is reversed and greater than the alarm threshold, otherwise cleared.
0x0287	647	Channel 8 current reverse alarm status	This bit is set when the channel current is reversed and greater than the alarm threshold, otherwise cleared.
0x0288	648	Channel 9 current reverse alarm status	This bit is set when the channel current is reversed and greater than the alarm threshold, otherwise cleared.
0x0289	649	Channel 10 current reverse alarm status	This bit is set when the channel current is reversed and greater than the alarm threshold, otherwise cleared.
0x028A	650	Channel 11 current reverse alarm status	This bit is set when the channel current is reversed and greater than the alarm threshold, otherwise cleared.
0x028B	651	Channel 12 current reverse alarm status	This bit is set when the channel current is reversed and greater than the alarm threshold, otherwise cleared.
0x028C	652	Channel 13 current reverse alarm status	This bit is set when the channel current is reversed and greater than the alarm threshold, otherwise cleared.
0x028D	653	Channel 14 current reverse alarm status	This bit is set when the channel current is reversed and greater than the alarm threshold, otherwise cleared.
0x028E	654	Channel 15 current reverse alarm status	This bit is set when the channel current is reversed and greater than the alarm threshold, otherwise cleared.
0x028F	655	Channel 16 current reverse alarm status	This bit is set when the channel current is reversed and greater than the alarm threshold, otherwise cleared.
0x0290	656	Channel 17 current reverse alarm status	This bit is set when the channel current is reversed and greater than the alarm threshold, otherwise cleared.
0x0291	657	Channel 18 current	This bit is set when the channel current is reversed and greater

		reverse alarm status	than the alarm threshold, otherwise cleared.
0x0292	658	Channel 19 current reverse alarm status	This bit is set when the channel current is reversed and greater than the alarm threshold, otherwise cleared.
0x0293	659	Channel 20 current reverse alarm status	This bit is set when the channel current is reversed and greater than the alarm threshold, otherwise cleared.
0x0294	660	Channel 21 current reverse alarm status	This bit is set when the channel current is reversed and greater than the alarm threshold, otherwise cleared.
0x0295	661	Channel 22 current reverse alarm status	This bit is set when the channel current is reversed and greater than the alarm threshold, otherwise cleared.
0x0296	662	Channel 23 current reverse alarm status	This bit is set when the channel current is reversed and greater than the alarm threshold, otherwise cleared.
0x0297	663	Channel 24 current reverse alarm status	This bit is set when the channel current is reversed and greater than the alarm threshold, otherwise cleared.
.....
0x02A0	672	Channel 1 no current alarm status	This bit is set to 1 when there is no current in this channel, otherwise cleared.
0x02A1	673	Channel 2 no current alarm status	This bit is set to 1 when there is no current in this channel, otherwise cleared.
0x02A2	674	Channel 3 no current alarm status	This bit is set to 1 when there is no current in this channel, otherwise cleared.
0x02A3	675	Channel 4 no current alarm status	This bit is set to 1 when there is no current in this channel, otherwise cleared.
0x02A4	676	Channel 5 no current alarm status	This bit is set to 1 when there is no current in this channel, otherwise cleared.
0x02A5	677	Channel 6 no current alarm status	This bit is set to 1 when there is no current in this channel, otherwise cleared.
0x02A6	678	Channel 7 no current alarm status	This bit is set to 1 when there is no current in this channel, otherwise cleared.
0x02A7	679	Channel 8 no current alarm status	This bit is set to 1 when there is no current in this channel, otherwise cleared.
0x02A8	680	Channel 9 no current alarm status	This bit is set to 1 when there is no current in this channel, otherwise cleared.
0x02A9	681	Channel 10 no current alarm status	This bit is set to 1 when there is no current in this channel, otherwise cleared.

0x02AA	682	Channel 11 no current alarm status	This bit is set to 1 when there is no current in this channel, otherwise cleared.
0x02AB	683	Channel 12 no current alarm status	This bit is set to 1 when there is no current in this channel, otherwise cleared.
0x02AC	684	Channel 13 no current alarm status	This bit is set to 1 when there is no current in this channel, otherwise cleared.
0x02AD	685	Channel 14 no current alarm status	This bit is set to 1 when there is no current in this channel, otherwise cleared.
0x02AE	686	Channel 15 no current alarm status	This bit is set to 1 when there is no current in this channel, otherwise cleared.
0x02AF	687	Channel 16 no current alarm status	This bit is set to 1 when there is no current in this channel, otherwise cleared.
0x02B0	688	Channel 17 no current alarm status	This bit is set to 1 when there is no current in this channel, otherwise cleared.
0x02B1	689	Channel 18 no current alarm status	This bit is set to 1 when there is no current in this channel, otherwise cleared.
0x02B2	690	Channel 19 no current alarm status	This bit is set to 1 when there is no current in this channel, otherwise cleared.
0x02B3	691	Channel 20 no current alarm status	This bit is set to 1 when there is no current in this channel, otherwise cleared.
0x02B4	692	Channel 21 no current alarm status	This bit is set to 1 when there is no current in this channel, otherwise cleared.
0x02B5	693	Channel 22 no current alarm status	This bit is set to 1 when there is no current in this channel, otherwise cleared.
0x02B6	694	Channel 23 no current alarm status	This bit is set to 1 when there is no current in this channel, otherwise cleared.
0x02B7	695	Channel 24 no current alarm status	This bit is set to 1 when there is no current in this channel, otherwise cleared.
.....
0x02C0	704	Channel 1 undercurrent alarm status	This bit is set to 1 when the channel is undercurrent, otherwise cleared.
0x02C1	705	Channel 2 undercurrent alarm status	This bit is set to 1 when the channel is undercurrent, otherwise cleared.
0x02C2	706	Channel 3 undercurrent alarm status	This bit is set to 1 when the channel is undercurrent, otherwise cleared.

0x02C3	707	Channel 4 undercurrent alarm status	This bit is set to 1 when the channel is undercurrent, otherwise cleared.
0x02C4	708	Channel 5 undercurrent alarm status	This bit is set to 1 when the channel is undercurrent, otherwise cleared.
0x02C5	709	Channel 6 undercurrent alarm status	This bit is set to 1 when the channel is undercurrent, otherwise cleared.
0x02C6	710	Channel 7 undercurrent alarm status	This bit is set to 1 when the channel is undercurrent, otherwise cleared.
0x02C7	711	Channel 8 undercurrent alarm status	This bit is set to 1 when the channel is undercurrent, otherwise cleared.
0x02C8	712	Channel 9 undercurrent alarm status	This bit is set to 1 when the channel is undercurrent, otherwise cleared.
0x02C9	713	Channel 10 undercurrent alarm status	This bit is set to 1 when the channel is undercurrent, otherwise cleared.
0x02CC	714	Channel 11 undercurrent alarm status	This bit is set to 1 when the channel is undercurrent, otherwise cleared.
0x02CB	715	Channel 12 undercurrent alarm status	This bit is set to 1 when the channel is undercurrent, otherwise cleared.
0x02CC	716	Channel 13 undercurrent alarm status	This bit is set to 1 when the channel is undercurrent, otherwise cleared.
0x02CD	717	Channel 14 undercurrent alarm status	This bit is set to 1 when the channel is undercurrent, otherwise cleared.
0x02CE	718	Channel 15 undercurrent alarm status	This bit is set to 1 when the channel is undercurrent, otherwise cleared.
0x02CF	719	Channel 16 undercurrent alarm status	This bit is set to 1 when the channel is undercurrent, otherwise cleared.
0x02D0	720	Channel 17 undercurrent alarm status	This bit is set to 1 when the channel is undercurrent, otherwise cleared.
0x02D1	721	Channel 18 undercurrent alarm status	This bit is set to 1 when the channel is undercurrent, otherwise cleared.
0x02D2	722	Channel 19 undercurrent alarm status	This bit is set to 1 when the channel is undercurrent, otherwise cleared.
0x02D3	723	Channel 20 undercurrent alarm status	This bit is set to 1 when the channel is undercurrent, otherwise cleared.
0x02D4	724	Channel 21 undercurrent	This bit is set to 1 when the channel is undercurrent, otherwise

		alarm status	cleared.
0x02D5	725	Channel 22 undercurrent alarm status	This bit is set to 1 when the channel is undercurrent, otherwise cleared.
0x02D6	726	Channel 23 undercurrent alarm status	This bit is set to 1 when the channel is undercurrent, otherwise cleared.
0x02D7	727	Channel 24 undercurrent alarm status	This bit is set to 1 when the channel is undercurrent, otherwise cleared.
.....
0x02E0	736	Channel 1 overcurrent alarm status	This bit is set to 1 when the channel is overcurrent, otherwise cleared.
0x02E1	737	Channel 2 overcurrent alarm status	This bit is set to 1 when the channel is overcurrent, otherwise cleared.
0x02E2	738	Channel 3 overcurrent alarm status	This bit is set to 1 when the channel is overcurrent, otherwise cleared.
0x02E3	739	Channel 4 overcurrent alarm status	This bit is set to 1 when the channel is overcurrent, otherwise cleared.
0x02E4	740	Channel 5 overcurrent alarm status	This bit is set to 1 when the channel is overcurrent, otherwise cleared.
0x02E5	741	Channel 6 overcurrent alarm status	This bit is set to 1 when the channel is overcurrent, otherwise cleared.
0x02E6	742	Channel 7 overcurrent alarm status	This bit is set to 1 when the channel is overcurrent, otherwise cleared.
0x02E7	743	Channel 8 overcurrent alarm status	This bit is set to 1 when the channel is overcurrent, otherwise cleared.
0x02E8	744	Channel 9 overcurrent alarm status	This bit is set to 1 when the channel is overcurrent, otherwise cleared.
0x02E9	745	Channel 10 overcurrent alarm status	This bit is set to 1 when the channel is overcurrent, otherwise cleared.
0x02EA	746	Channel 11 overcurrent alarm status	This bit is set to 1 when the channel is overcurrent, otherwise cleared.
0x02EB	747	Channel 12 overcurrent alarm status	This bit is set to 1 when the channel is overcurrent, otherwise cleared.
0x02EC	748	Channel 13 overcurrent alarm status	This bit is set to 1 when the channel is overcurrent, otherwise cleared.

0x02ED	749	Channel 14 overcurrent alarm status	This bit is set to 1 when the channel is overcurrent, otherwise cleared.
0x02EE	750	Channel 15 overcurrent alarm status	This bit is set to 1 when the channel is overcurrent, otherwise cleared.
0x02EF	751	Channel 16 overcurrent alarm status	This bit is set to 1 when the channel is overcurrent, otherwise cleared.
0x02F0	752	Channel 17 overcurrent alarm status	This bit is set to 1 when the channel is overcurrent, otherwise cleared.
0x02F1	753	Channel 18 overcurrent alarm status	This bit is set to 1 when the channel is overcurrent, otherwise cleared.
0x02F2	754	Channel 19 overcurrent alarm status	This bit is set to 1 when the channel is overcurrent, otherwise cleared.
0x02F3	755	Channel 20 overcurrent alarm status	This bit is set to 1 when the channel is overcurrent, otherwise cleared.
0x02F4	756	Channel 21 overcurrent alarm status	This bit is set to 1 when the channel is overcurrent, otherwise cleared.
0x02F5	757	Channel 22 overcurrent alarm status	This bit is set to 1 when the channel is overcurrent, otherwise cleared.
0x02F6	758	Channel 23 overcurrent alarm status	This bit is set to 1 when the channel is overcurrent, otherwise cleared.
0x02F7	759	Channel 24 overcurrent alarm status	This bit is set to 1 when the channel is overcurrent, otherwise cleared.
.....
0x0300	768	Channel 1 current low alarm state	This bit is set to 1 when the channel current is too low, otherwise cleared.
0x0301	769	Channel 2 current low alarm state	This bit is set to 1 when the channel current is too low, otherwise cleared.
0x0302	770	Channel 3 current low alarm state	This bit is set to 1 when the channel current is too low, otherwise cleared.
0x0303	771	Channel 4 current low alarm state	This bit is set to 1 when the channel current is too low, otherwise cleared.
0x0304	772	Channel 5 current low alarm state	This bit is set to 1 when the channel current is too low, otherwise cleared.
0x0305	773	Channel 6 current low alarm state	This bit is set to 1 when the channel current is too low, otherwise cleared.

0x0306	774	Channel 7 current low alarm state	This bit is set to 1 when the channel current is too low, otherwise cleared.
0x0307	775	Channel 8 current low alarm state	This bit is set to 1 when the channel current is too low, otherwise cleared.
0x0308	776	Channel 9 current low alarm state	This bit is set to 1 when the channel current is too low, otherwise cleared.
0x0309	777	Channel 10 current low alarm state	This bit is set to 1 when the channel current is too low, otherwise cleared.
0x030A	778	Channel 11 current low alarm state	This bit is set to 1 when the channel current is too low, otherwise cleared.
0x030B	779	Channel 12 current low alarm state	This bit is set to 1 when the channel current is too low, otherwise cleared.
0x030C	780	Channel 13 current low alarm state	This bit is set to 1 when the channel current is too low, otherwise cleared.
0x030D	781	Channel 14 current low alarm state	This bit is set to 1 when the channel current is too low, otherwise cleared.
0x030E	782	Channel 15 current low alarm state	This bit is set to 1 when the channel current is too low, otherwise cleared.
0x030F	783	Channel 16 current low alarm state	This bit is set to 1 when the channel current is too low, otherwise cleared.
0x0310	784	Channel 17 current low alarm state	This bit is set to 1 when the channel current is too low, otherwise cleared.
0x0311	785	Channel 18 current low alarm state	This bit is set to 1 when the channel current is too low, otherwise cleared.
0x0312	786	Channel 19 current low alarm state	This bit is set to 1 when the channel current is too low, otherwise cleared.
0x0313	787	Channel 20 current low alarm state	This bit is set to 1 when the channel current is too low, otherwise cleared.
0x0314	788	Channel 21 current low alarm state	This bit is set to 1 when the channel current is too low, otherwise cleared.
0x0315	789	Channel 22 current low alarm state	This bit is set to 1 when the channel current is too low, otherwise cleared.
0x0316	790	Channel 23 current low alarm state	This bit is set to 1 when the channel current is too low, otherwise cleared.

0x0317	791	Channel 24 current low alarm state	This bit is set to 1 when the channel current is too low, otherwise cleared.
.....
0x0320	800	Channel 1 current too high alarm state	This bit is set to 1 when the channel current is too high, otherwise cleared.
0x0321	801	Channel 2 current too high alarm state	This bit is set to 1 when the channel current is too high, otherwise cleared.
0x0322	802	Channel 3 current too high alarm state	This bit is set to 1 when the channel current is too high, otherwise cleared.
0x0323	803	Channel 4 current too high alarm state	This bit is set to 1 when the channel current is too high, otherwise cleared.
0x0324	804	Channel 5 current too high alarm state	This bit is set to 1 when the channel current is too high, otherwise cleared.
0x0325	805	Channel 6 current too high alarm state	This bit is set to 1 when the channel current is too high, otherwise cleared.
0x0326	806	Channel 7 current too high alarm state	This bit is set to 1 when the channel current is too high, otherwise cleared.
0x0327	807	Channel 8 current too high alarm state	This bit is set to 1 when the channel current is too high, otherwise cleared.
0x0328	808	Channel 9 current too high alarm state	This bit is set to 1 when the channel current is too high, otherwise cleared.
0x0329	809	Channel 10 current too high alarm state	This bit is set to 1 when the channel current is too high, otherwise cleared.
0x032A	810	Channel 11 current too high alarm state	This bit is set to 1 when the channel current is too high, otherwise cleared.
0x032B	811	Channel 12 current too high alarm state	This bit is set to 1 when the channel current is too high, otherwise cleared.
0x032C	812	Channel 13 current too high alarm state	This bit is set to 1 when the channel current is too high, otherwise cleared.
0x032D	813	Channel 14 current too high alarm state	This bit is set to 1 when the channel current is too high, otherwise cleared.
0x032E	814	Channel 15 current too high alarm state	This bit is set to 1 when the channel current is too high, otherwise cleared.
0x032F	815	Channel 16 current too high alarm state	This bit is set to 1 when the channel current is too high, otherwise cleared.

0x0330	816	Channel 17 current too high alarm state	This bit is set to 1 when the channel current is too high, otherwise cleared.
0x0331	817	Channel 18 current too high alarm state	This bit is set to 1 when the channel current is too high, otherwise cleared.
0x0332	818	Channel 19 current too high alarm state	This bit is set to 1 when the channel current is too high, otherwise cleared.
0x0333	819	Channel 20 current too high alarm state	This bit is set to 1 when the channel current is too high, otherwise cleared.
0x0334	820	Channel 21 current too high alarm state	This bit is set to 1 when the channel current is too high, otherwise cleared.
0x0335	821	Channel 22 current too high alarm state	This bit is set to 1 when the channel current is too high, otherwise cleared.
0x0336	822	Channel 23 current too high alarm state	This bit is set to 1 when the channel current is too high, otherwise cleared.
0x0337	823	Channel 24 current too high alarm state	This bit is set to 1 when the channel current is too high, otherwise cleared.

Register description in word unit (function code 03 04 06)

Modbus address		Function description	Data Type	instruction	R/W
Hex	Decimal				
Address 0x0100 ~ 0x0158, a total of 89 consecutive addresses					
Address 0x0100 ~ 0x0123, a total of 36 consecutive addresses (data in this address supports data freeze)					
0x0100	256	reserved			R
0x0101	257	reserved			R
0x0102	258	reserved			R
0x0103	259	reserved			
0x0104	260	bus voltage	Unsigned short	Unit V, default 0	R
0x0105	261	Temperature sensor 1	short	Unit: 0.1 ° C, default -424	R
0x0106	262	Temperature sensor 2	short	Unit: 0.1 ° C, default -424	R
0x0107	263	Switch input	Unsigned short	bit0: DI1, bit1: DI2, bit2: DI3, bit3: DI4 0: open, 1: closed, default 0	R
0x0108	264	Quantity of online Hall channels	Unsigned short	Shows the quantity of Hall channels currently connected. default 0	R
0x0109	265	Total reverse current	short	Unit is 10mA, default is 0	R
0x010A	266	Total current	Short	Unit is 10mA, default is 0,	R
0x010B	267	Average current	Short	Unit mA, default 0	
0x010C	268	Channel 1 to 24 current	Short	Unit mA, default 0	R
~	~				
0x0123	291				
Address 0x012D ~ 0x0158, a total of 45 addresses (function code 04 read, but the data is not latched)					
0x012D	301	Alarm status 1	Unsigned short	Bit0 bus arc, bit1 channel arc, bit2 low voltage, bit3 high voltage, bit4 high temperature 1, bit5 high temperature 2, bit6 channel current value is reversed, bit7 reverse total current is high, bit8 total current is low, bit9 total current is high, bit10 channel current value is zero, bit11 channel current value undercurrent, bit12 channel current value overcurrent, bit13 channel current value is low, bit14 channel current value is high, 0: No alarm, 1: Alarm, default 0	R
0x012E	302	reserved			

0x012D	303	reserved			
0x0130	304	Channel 1 ~ 16 arc alarm	Unsigned short	Default 0 0: No alarm, 1: Alarm	R
0x0131	305	Channel 17 ~ 24 arc alarm	Unsigned short	Default 0 0: No alarm, 1: Alarm	R
0x0132	306	The quantity of Bus arc history alarm	Unsigned short	If the current channel alarms continuously, the value will increase by 1. If there are alarms on other channels, the count will restart.	R
0x0133 ~ 0x014A	307 ~ 330	The quantity of Channel 1~24 arc history alarm	Unsigned short	default 0 This value is incremented by 1 for each channel arc alarm.	R
0x014B	331	Channel 1 ~ 16 reverse current alarm	Unsigned short	Default 0 0: No alarm, 1: Alarm	R
0x014C	332	Channel 17 ~ 24 reverse current alarm	Unsigned short	Default 0 0: No alarm, 1: Alarm	R
0x014D	333	Channel 1 ~ 16 no current alarm	Unsigned short	Default 0 0: No alarm, 1: Alarm	R
0x014E	334	Channel 17 ~ 24 no current alarm	Unsigned short	Default 0 0: No alarm, 1: Alarm	R
0x014F	335	Channel 1 ~ 16 undercurrent alarm	Unsigned short	Default 0 0: No alarm, 1: Alarm	R
0x0150	336	Channel 17 ~ 24 undercurrent alarm	Unsigned short	Default 0 0: No alarm, 1: Alarm	R
0x0151	337	Channel 1 ~ 16 overcurrent alarm	Unsigned short	Default 0 0: No alarm, 1: Alarm	R
0x0152	338	Channel 17 ~ 24 overcurrent alarm	Unsigned short	Default 0 0: No alarm, 1: Alarm	R
0x0153	339	Channel 1 ~ 16 current low alarm	Unsigned short	Default 0 0: No alarm, 1: Alarm	R
0x0154	340	Channel 17 ~ 24 current low alarm	Unsigned short	Default 0 0: No alarm, 1: Alarm	R
0x0155	341	Channel 1 ~ 16 current high alarm	Unsigned short	Default 0 0: No alarm, 1: Alarm	R
0x0156	342	Channel 17 ~ 24 current high alarm	Unsigned short	Default 0 0: No alarm, 1: Alarm	R
0x0157	343	Channel 1 ~ 16 arc channel self-check status	Unsigned short	default 0 0 means self-check passed, 1 means self-check failed	R
0x0158	344	Channel 17 ~ 24 arc channel self-check status	Unsigned short	default 0 0 means self-check passed, 1 means self-check failed	R

The address 0x0200 ~ 0x02FF, which has a total of 128 consecutive addresses. It is recommended to read in sections.

Power information (0x0200-0x024b)

0x0200	512	Total power	Unsigned	Unit is 100W, default is 0	R
--------	-----	-------------	----------	----------------------------	---

			short		
0x0201	513	Average power	Unsigned short	Unit W, default 0	R
0x0202 ~ 0x0219	514 ~ 537	Channel 1 ~ 24 power	Unsigned short	Unit W, default 0	R
0x021A	538	The higher 16bit of the total generated energy	Unsigned short	Unit Wh, default 0	R
0x021B	539	The lower 16bit of the total generated energy	Unsigned short	Unit Wh, default 0	R
0x021C	540	The higher 16bit of the generated energy of channel1	Unsigned short	Unit Wh, default 0	R
0x021D	541	The lower 16bit of the generated energy of channel1	Unsigned short	Unit Wh, default 0	R
.....
0x024A	586	The higher 16bit of the generated energy of Channel 24	Unsigned short	Unit Wh, default 0	R
0x024B	587	The lower 16bit of the generated energy of Channel 24	Unsigned short	Unit Wh, default 0	R
Arc information (0x0250-0x0297)					
0x0250 ~ 0x0267	592 ~ 615	Channel 1~24 arc intensity real-time value	short	Unit 1, default 0	R
0x0268 ~ 0x027F	616 ~ 639	Channel 1~24 arc intensity history maximum	short	Unit 1, default 0	R
0x0280 ~ 0x0297	640 ~ 663	Channel 1 ~ 24 10 minutes arc intensity value	short	Unit 1, default 0	R
FR-DCMG-HS4Q Hall Special Register Large Range Current Power Information (0x0400-0x0434)					
0x0400	1024	Channel 1 current value	short	Unit 10mA, default 0	
0x0401	1025	Channel 2 current value	short	Unit 10mA, default 0	
.....
0x0416	1046	Channel 23 current value	short	Unit 10mA, default 0	
0x0417	1047	Channel 24 current value	short	Unit 10mA, default 0	
0x0418	1048	Total reverse current	short	Unit 100mA, default 0	

0x0419	1049	Total current	short	Unit 100mA, default 0	
0x041A	1050	Average current	short	Unit 10mA, default 0	
0x041B	1051	Total power	short	Unit 1000W, default 0	
0x041C	1052	Average power	short	Unit 10W, default 0	
0x041D ~ 0x0434	1053 ~ 1076	Channel 1 ~ 24 power	short	Unit 10W, default 0	

**FR-DCMG-HS4Q Hall special register Large-scale energy information
(0x0500-0x0540)**

0x0500	1280	The higher 16bit of the total generated energy	Unsigned short	Unit 10Wh, default 0	
0x0501	1281	The lower 16bit of the total generated energy	Unsigned short	Unit 10Wh, default 0	
0x0502	1282	The higher 16bit of the generated energy of channel1	Unsigned short	Unit 10Wh, default 0	
0x0503	1283	The lower 16bit of the generated energy of channel1	Unsigned short	Unit 10Wh, default 0	
.....
0x0539	1343	The higher 16bit of the generated energy of channel24	Unsigned short	Unit 10Wh, default 0	
0x0540	1344	The lower 16bit of the generated energy of channel24	Unsigned short	Unit 10Wh, default 0	

System information configuration (0x0B00-0x0B24)

0x0B00	2816	Alarm release	Unsigned Short	The percentage of the alarm threshold is used as the alarm release threshold. Unit %, default 2, setting range 0 to 100	W/R
0x0B01	2817	Bus voltage alarm low threshold	Unsigned short	Unit V, default 300	W/R
0x0B02	2818	Bus voltage alarm high threshold	Unsigned short	Unit V, default 1500	W/R
0x0B03	2819	Temperature sensor 1 alarm high threshold	short	Unit 0.1 ° C, default 800, setting range is greater than -400	W/R
0x0B04	2820	Temperature sensor 2 alarm high threshold	short	Unit 0.1 ° C, default 800, setting range is greater than -400	W/R
0x0B05	2821	Total current low alarm	Unsigned	Unit 10mA, default 1600	W/R

		threshold	Short		
0x0B06	2822	Total current too high alarm threshold	Unsigned Short	Unit 10mA, default 50000	W/R
0x0B07	2823	Current channel related alarm activation threshold	Unsigned Short	Unit mA, default 2000. The average current value is greater than this value; the total current is too high, too low, the channel is undercurrent, overcurrent, no current, high current, low current, otherwise these alarms will be forcibly turned off.	W/R
0x0B08	2824	Undercurrent, overcurrent alarm threshold	Unsigned short	Unit mA, default 2000. The average current is subtracted from this value as the undercurrent alarm threshold; the average current is added to this value as the overcurrent alarm threshold.	W/R
0x0B09	2825	Channel current low alarm threshold	Unsigned short	Unit mA, default 1000.	W/R
0x0B0A	2826	Channel current high alarm threshold	Unsigned short	Unit mA, default 20000.	W/R
0x0B0B	2827	Reverse total current too high threshold	short	Unit 10mA, default -600.	W/R
0x0B0C	2828	Channel reverse current too high threshold	short	Unit mA, default -2000.	W/R
0x0B0D	2839	-	-	-	
0x0B0E	2830	Channel arc intensity super high alarm threshold	Short	The default is 70. Need to set according to the site conditions or customer requirements, you can call the company's technical staff	W/R
0x0B0F	2831	reserved			
0x0B10	2832	reserved			
0x0B11	2833	Automatic current calibration setting	Bool	Write 1 to enable automatic current calibration, write 0 to disable, default is 0	W/R
0x0B12	2834	Manual current calibration setting	Bool	Write 1 to start current calibration, write 0 to turn off, default is 0 Note: Make sure the channel has no current when starting calibration.	W/R
0x0B13	2835	Channel 1~16 current channel switch setting	Unsigned short	bit0: Represents the switch setting for channel 1 bit15: Represents the switch setting for channel 16 0 means disabled, 1 means enabled Default 0xFFFF	W/R
0x0B14	2836	Channel 17~24 current channel switch setting	Unsigned short	bit0: Represents the switch setting for channel 7	W/R

				<p>bit7: Represents the switch setting for channel 24 0 means disabled, 1 means enabled Default 0xFFFF</p>	
0x0B15	2837	External power management time setting	Unsigned short	Unit M (min), default 120 minutes. When the photovoltaic power supply stops, the host can be powered by external 24 power sources, and the power supply time can be set.	W/R
0x0B16	2838	Current UI display, direction, reverse order control	Unsigned short	<p>0-8: Y-axis scale setting of UI interface 0 means the UI interface displays the current up to 10A 1 means the UI interface displays the current up to 20A 2 means the UI interface displays a maximum current of 30A 3 means the UI interface displays a maximum current of 40A 4 means the UI interface displays a maximum current of 50A 5 means the UI interface displays a maximum current of 60A</p> <p>Bit8: current channel forward / reverse sequence setting (Positive sequence: 1 ~ 24 channels arranged near the host Hall; Reverse order: Calculate from 24 to 1 channel near the host Hall) 0 means positive order; 1 means reverse order</p> <p>Bit9: Channel current direction setting 0 means the direction is positive, 1 means the current is reversed.</p> <p>Bit10: Auto range enable 0x0401 by default;</p>	W/R
0x0B17	2839	reserved			
0x0B20	2848	Alarm function management 1	Unsigned short	<p>Bit0 Bus arc, bit1 Channel arc, bit2 Low pressure, bit3 Over pressure, bit4 High temperature 1,</p>	W/R

				bit5 High temperature 2, bit6 Channel current value is reversed, bit7 Reverse total current is high, bit9 The total current is high, bit10 Channel current value is zero, bit11 Channel current value is undercurrent, bit12 Channel current value is overcurrent, bit13 The channel current value is low, bit14 The channel current value is high, 1: enable (open) alarm, 0: disable(close) alarm Default: 0x0002	
0x0B21	2849	Alarm function management 2	Unsigned short	bit0 DI1 bit1 DI2 bit2 DI3 bit3 DI4 bit14: - bit15: General alarm switch, (function is forcibly turned on) 1: enable alarm, 0: disable alarm Default value: 0x800F	W/R
System information configuration 2 (0x0C00-0x0C06)					W/R
0x0C00	3072	Clear power generation history value record	Unsigned short	Write 1 reset energy history record, read always 0	W/R
0x0C01	3073	Clear channel arc and bus arc history alarms	Unsigned short	Write 1 reset channel arc and bus arc history alarm times record, read always 0	W/R
0x0C05	3077	Arc channel self-check operation	Unsigned short	Write 1 to start the arc channel self-check, 1S to end the self-check. read always 0	W/R
System settings (0xFE00-0xFE54)					
0xFE00	65024	Modbus address	Unsigned short	Set range 1 ~ 247, default 247. Set other values to restore the default values.	W/R
0xFE01	65025	Modbus Baud rate	Unsigned short	1: 2400, 2: 4800, 3: 9600, 4: 19200, 5: 38400 Default is 3	W/R
0xFE02	65026	Modbus Parity	Unsigned short	0: NONE, 1: ODD, 2: EVEN Default is 0	W/R
0xFE06	65030	System UI display settings	Unsigned short	Lower 8 bits: system language setting 0: Chinese; 1: English, default value 1 High eight bits: system logo settings Reserved, default 0	W/R

Document revision record

Revision	Time	Description
3.1	2016-4-16	1. Add the alarm recording function of trip failure; 2. Receive background authorization; 3. Support to read the log through Modus.
3.2	2016-5-03	1. Realize automatic allocation of address; 2. Add data freezing function; 3. Add broadcasting function.
3.3	2016-6-19	1. The peak current range of the interface can be set to 10A, 20A and 30A by modifying the bar graph. 2. Increase the frequency of statistical arc alarm. 3. Add the function of log clearance, which can be removed manually or by Modbus.
3.4	2017-7-14	1. Add component status detection 2. Update the software version number
3.8	2018-4-12	Update the internal register list
3.9	2019-12-26	Update register description, switch alarm description
4.0	2020-01-13	Update the switch value description, new program interface and alarm interface; New-Current calibration function, interface and register ——Arc intensity 10 minutes value register ——High/low level switching function, interface and register in trip mode ——Arc Alarm Strategy Deletion-broadcast, battery board and other registers
4.1	2020-04-14	For A025 and above products Update switch description, terminal definition, new setting interface and alarm interface; Add ——Arc Intensity 10 Minute Value Register ——Arc Alarm Strategy

		<ul style="list-style-type: none"> ——Communication shielded wire wiring specification ——Current calibration function, interface and register ——FAQ (screen flicker troubleshooting method) ——Controller connection diagram <p>Delete-Broadcast, battery board and other registers</p>
4.2	2020-07-06	<p>For A028 and above products</p> <p>Add</p> <ul style="list-style-type: none"> ——HS4Q large range registers 0x0400, 0x0500
4.3	2020-08-07	<p>Terminal definition picture update</p> <p>The picture voltage matches the description voltage</p> <p>Delete FAQ</p>
4.4	2021-08-02	<p>Change——0x0B16 (2838) range, current direction, current reverse sequence register</p> <p>Delete——broadcast related registers</p>
4.5	2021-08-05	<p>The software version number is changed to A029, and the corresponding picture is also changed;</p> <p>Delete——all the registers related to the trip part;</p> <p>Modification——delete the alarm trip register 0x0B23, 0x0B24;</p> <ul style="list-style-type: none"> ——The default value of 0x0B20 "Alarm Function Management" register is changed to 0x0002; ——0x0B20 "low voltage" is changed to "bus voltage is too low"; "Overvoltage" is changed to "Bus voltage is too high"; ——Modify the histogram picture of the host; ——Modify the 2818 voltage over-voltage threshold to 1500V; ——Modify 2822 current over-current threshold to 500A; ——Modify the default value of 261 and 262 registers to -424;
4.6	2021-08-19	<p>Change——text description of the range, the minimum range is -6A when the range is 30A, and the minimum range is -8A when the range is 40A</p>

Contact us

If you have any questions about this product, please contact us. Please remember the following contact information:

Fonrich (Shanghai) New Energy Technology Co., Ltd.

Add: 1st Floor, Building 5, No.999 Jianguyue Road, Minhang District, Shanghai

Zip code: 201114 Tel :+86 21 61679672

Fax:+86 21 60717306 Email: sales@fonrich.com

Website: www.fonrich.com